

Thorix EVOLUTION 2C

Hydraulic device for controlling one direct heating circuit and a secondary mixed heating circuit

Compatible with all types of generator



Installation and operating instructions

**Thorix EVOLUTION 2C
with outdoor sensor**
Ref. 411003



The information contained in this document is non-contractual. The manufacturer reserves the right to modify technical data and equipment of any appliances without prior notice.

**Made
in France**



Manual ref: 1898557
Edition n°: 23.39

CONTENTS

1 - IMPORTANT: PLEASE READ IMMEDIATELY . 3

- 1.1 - Important information..... 3
- 1.2 - Safety instructions and advice..... 3
- 1.3 - General delivery conditions..... 3
- 1.4 - Storage and transport..... 3

2 - INTRODUCTION 4

- 2.1 - Operating..... 4
- 2.2 - Hydraulic connection 4
- 2.3 - Technical data 4
- 2.4 - Accessoires 5
- 2.5 - Initial programming..... 5
- 2.6 - Installation recommendations..... 5
 - 2.6.1 - Domestic hot water production linked to a heat generator 5
 - 2.6.2 - Underfloor heating as circuit 2..... 5
 - 2.6.3 - Direct circuit
(whether or not it is registered as circuit n°1 on the THORIX) 5
- 2.7 - Hydraulics diagrams 6
 - 2.7.1 - Mixed circuit (circuit n°2) generator with 1 circulator pump
for heating and 1 circulator pump for domestic hot water 6
 - 2.7.2 - Mixed circuit (circuit n°2) + direct circuit (circuit n°1) generator with
1 heating circulator pump and 1 3-way valve for domestic hot water. 6

3 - INSTALLATION..... 7

- 3.1 - Installation site..... 7
- 3.2 - Hydraulic connections 7
 - 3.2.1 - Buffer Volume on Generator Return 7
 - 3.2.2 - Connecting to primary circuit and heating circuits 7
 - 3.2.3 - Characteristics of low-energy, variable-speed circulator pump..... 7
 - 3.2.4 - Characteristics of by-pass with check valve..... 7
 - 3.2.5 - Application for radiator or fan coil unit circuit(s) 7
 - 3.2.6 - Application for underfloor heating circuit(s) 8
- 3.3 - Treatment of heating circuit water 8
 - 3.3.1 - Preparing the hydraulic circuit 8
 - 3.3.2 - Water for filling the tank..... 8
 - 3.3.3 - Heating circuit treatment 8
 - 3.3.4 - Degassing the installation..... 8
- 3.4 - Electrical connections 9
 - 3.4.1 - Accessing electrical connections..... 9
 - 3.4.2 - Electrical diagram..... 10
 - 3.4.3 - Power supply and electrical safety..... 10
 - 3.4.4 - Electrical connections..... 10
 - 3.4.5 - Using the "outdoor temperature deduction" function..... 11
 - 3.4.6 - Using the "heat pump de-icing assistance" function..... 11
 - 3.4.7 - Power supply to boiler controlled by 65°C safety aquastat where
the secondary circuit is an underfloor heating circuit..... 11
 - 3.4.7.1 - Boiler with < 4A power supply..... 11
 - 3.4.7.2 - Boiler with ≥ 4A power supply or high temperature heat pump
(≥ 65°C) or heat pump with boiler or electrical back-up 11
 - 3.4.7.3 - Low temperature heat pump (< 65°C) 12
 - 3.4.8 - Boiler or heat pump with 2 underfloor heating circuits..... 12

4 - SET UP 12

- 4.1 - Control box 12
- 4.2 - Installer menu 13
- 4.3 - Configuration of the installation 13
- 4.4 - Purging 14
- 4.5 - Manual or automatic setting on the secondary mixed circuit 14
- 4.6 - Settings..... 15
 - 4.6.1 - General parametres 15
 - 4.6.2 - Circuit 1 (direct) control..... 17
 - 4.6.3 - Circuit 2 (mixed) control..... 17
 - 4.6.3.1 - Circuit 2 (mixed) heating curve..... 18
 - 4.6.3.2 - Heat pump de-icing assistance..... 18
 - 4.6.3.3 - Minimum position of 3-way valve modulation 18
- 4.7 - Adjusting flow rates ("Balancing" function) 18
- 4.8 - Resetting installer parametres 19
- 4.9 - Display 19

5 - USE..... 20

- 5.1 - Setting the date and time..... 20
- 5.2 - Programming heating mode time periods 20
 - 5.2.1 - Creating a new programme..... 21
 - 5.2.2 - Copying existing programmes 21
 - 5.2.2.1 - Copying programme from day before 21
 - 5.2.2.2 - Copying a pre-recorded programme..... 22
 - 5.2.3 - Modifying a programme..... 22
 - 5.2.4 - View programme 22
- 5.3 - User Menu 23
 - 5.3.1 - Adjusting target temperatures for Circuit 1 (direct)
and Circuit 2 (mixed) 23
 - 5.3.1.1 - Setting ambient temperature 1 or 2..... 23
 - 5.3.1.2 - Setting Ambient Temperature ECO 1 or 2..... 23
 - 5.3.1.3 - Setting Ambient Temperature FROST PROTECTION 1 or 2..... 23
 - 5.3.2 - Setting a holiday period..... 24
 - 5.3.3 - Stopping the Thorix EVOLUTION 24
 - 5.3.4 - Temporary override of set comfort mode
by programming a time period..... 24
 - 5.3.5 - Selecting summer / winter modes 25
 - 5.3.6 - Setting the language..... 25
 - 5.3.7 - Accessing measurements (temperatures, contact) and operating
information (circulator pump and 3-way valve)..... 25

6 - MAINTENANCE AND REPAIRS LOCKING THE KEYBOARD 25

- 6.1 - Maintenance aids in the installer menu 25
 - 6.1.1 - Accessing measurements (temperatures, contact) and
operating information (circulator pump and 3-way valve) 25
 - 6.1.2 - Viewing counters and meters 26
- 6.2 - Locking the keyboard 26
 - 6.2.1 - Lock = *NO* 26
 - 6.2.2 - Lock = *AUTO* 26
 - 6.2.3 - Lock = *PRO* 26
- 6.3 - Error messages..... 27
- 6.4 - Sensor data curve charts..... 28
 - 6.4.1 - Boiler, outgoing, incoming 3WV and DHW sensors..... 28
 - 6.4.2 - Outdoor sensor 28
- 6.5 - Maintenance..... 28
 - 6.5.1 - Water circuit..... 29
 - 6.5.2 - Troubleshooting..... 29

7 - PARTS 29

8 - WARRANTY 30

- 8.1 - Warranty limits..... 30
 - 8.1.1 - General information 30
 - 8.1.2 - Cases (unlimited) for exclusion from warranty..... 30
 - 8.1.2.1 - Heating circuit water 30
 - 8.1.2.2 - Handling..... 30
 - 8.1.2.3 - Installation site..... 30
 - 8.1.2.4 - Electrical connections 30
 - 8.1.2.5 - Hydraulic connections 30
 - 8.1.2.6 - Accessories 31
 - 8.1.2.7 - Maintenance 31

9 - GLOSSARY..... 31

1 - IMPORTANT: PLEASE READ IMMEDIATELY

1.1 - Important information

These installation and operating instructions form part of the appliances which they refer to. In order for the warranty to be valid, they must be read before using the appliances.

This manual must be kept and passed on to successive users for future reference. It will be considered as evidence in case of litigation.

The safety instructions given in the manual must be strictly respected.

- Rinse and clean the hydraulic heating circuits before connecting the appliance.
- The appliance can only function with water in it. Never switch on the appliances if the installation has not been filled with water first.
- It is recommended that you carry out checks for limescale and sludge periodically and clean if necessary.
- Always switch off the power supply before any work is undertaken on the appliance.
- Do not submerge any electrical parts or control components of the appliance in water.

Before carrying out any connections, please ensure that the appliance is compatible with the installation.

Before switching on the power supply, please check that the network tension which the appliance will be connected to is the same as the one indicated on the rating plate of the appliance. Before any maintenance work or handling, or in case of breakdown or incorrect operation, always disconnect the appliance from the power supply and seek advice from a specialist.



If Circuit 2 (mixed) is an underfloor heating circuit, the power supply of the boiler must be controlled from the underfloor temperature limiter on the Thorix EVOLUTION (see § "Electrical connections").

The manufacturer is not responsible for any damage caused by failure to follow the instructions provided, errors in handling, installation or use.

These installation and operating instructions is subject to change without notice.

1.2 - Safety instructions and advice

The **Thorix EVOLUTION** must only be installed indoors, in premises protected from bad weather and frost.

- It is **FORBIDDEN** to install the **Thorix EVOLUTION** outdoors.
- This appliance is not intended for use by people (including children) who have reduced physical, sensory or mental capacities, or by people who have insufficient experience or knowledge of the product, unless they are being supervised by someone who is responsible for their safety and in possession of the instructions on how the appliance should be used.
- It is **FORBIDDEN** to use the appliance if the installation has no water in it.
- Any work on the appliance must be carried out by a qualified professional and with the power supply switched off.
- This appliance must be installed in accordance with national electrical installation rules. Check that the installation is equipped with a correctly sized and connected ground cable.

1.3 - General delivery conditions

In general, the material is transported at the recipient's risk.

It is essential to check that all the elements have been received and that no damage has been sustained during transport upon receipt of the appliance and before beginning the installation procedure.

1.4 - Storage and transport

Acceptable temperature range from -20°C to +60°C.

The appliance must be stored and transported in its original packaging and completely empty of any water.

2 - INTRODUCTION

The **Thorix EVOLUTION** manages and controls a mixed heating circuit (circuit n°2) according to outdoor temperature and as an option to a direct heating circuit (circuit n°1) which is controlled by a thermostat or ambient temperature sensor, using energy provided by a boiler or a heat pump.

2.1 - Operating

The **Thorix EVOLUTION** is equipped with an electronically-controlled, 3-way mixing valve which adjusts the temperature of the outgoing water (to the radiators or underfloor heating) according to outdoor temperature (with an outdoor sensor) and the temperature in the space that is to be heated (with or without a thermostat or interactive ambient temperature sensor).

it is equipped with an electronically-controlled motorised 2-way valve, which allows the water coming from the boiler to flow straight to Circuit 1 (direct) - radiators or underfloor heating - according to the temperature in the space that is to be heated (a thermostat or ambient temperature sensor is necessary in this case).

The advantages:

- The technology of the **Thorix EVOLUTION** is reliable and low-noise (electronically-controlled circulator pump and valve).
- Quick and easy access to components.

2.2 - Hydraulic connection

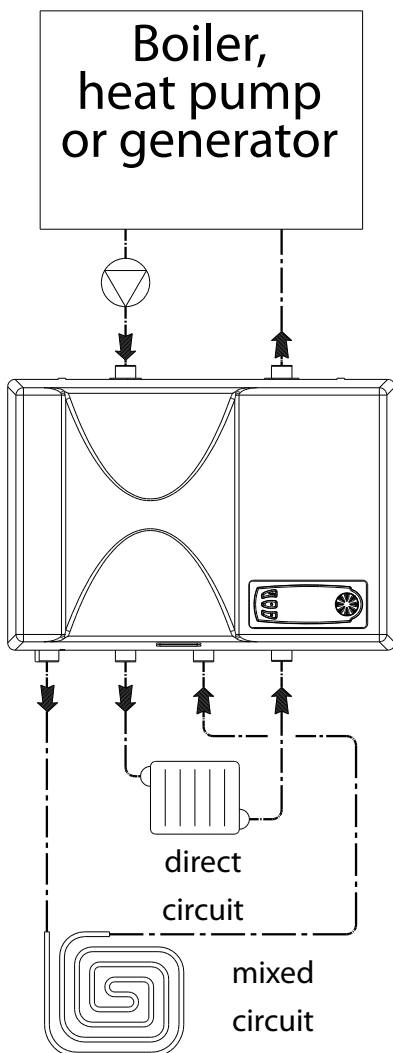

2.3 - Technical data

Dimensions	
Height	286 mm
Width	420 mm
Depth	260 mm
Hydraulic connections	3/4"
Weight	10 kg
Installation max. power	18 kW

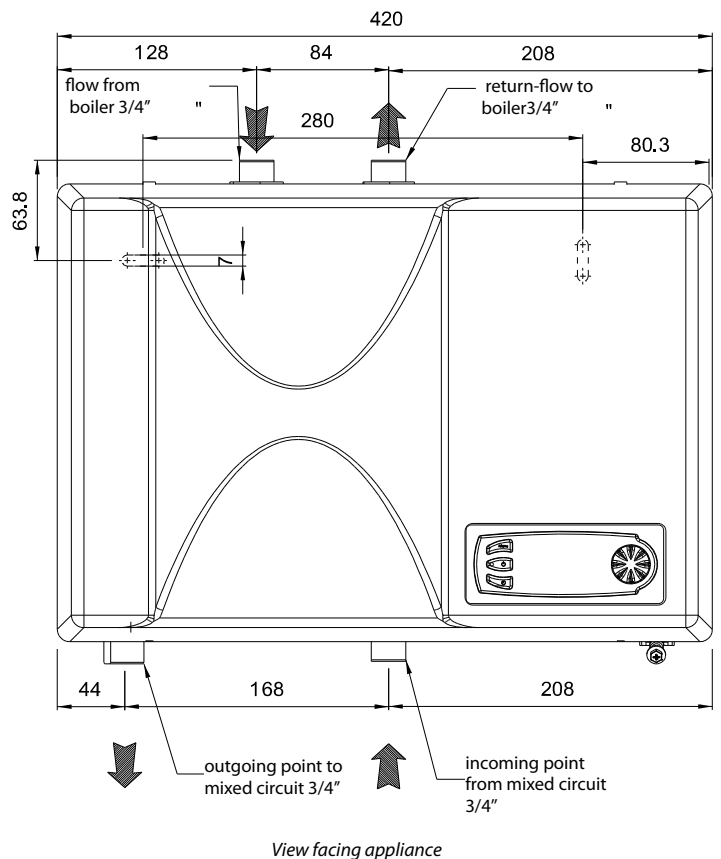
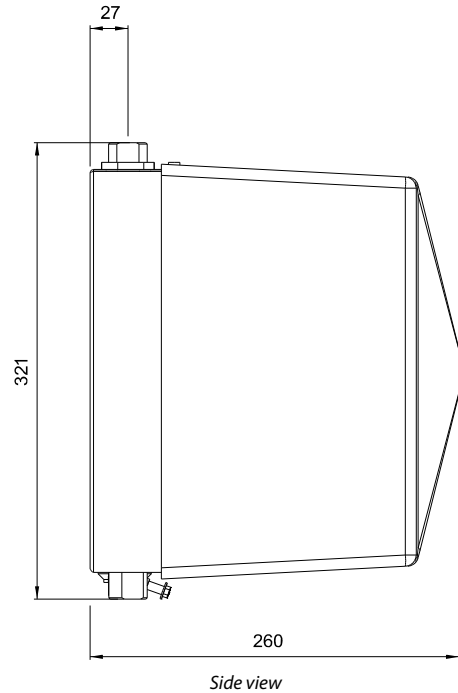

2.4 - Accessoires

The components described below are optional:

- Room thermostat (RT) -Ref. 710043-

For controlling ambient temperature without automatically correcting the desired set temperature (see § "Regulator settings").

- Room thermostat with clock/timer for weekly programming (CT) -Ref. 710044-

For controlling ambient temperature without automatically correcting the desired set temperature (see § "Regulator settings").

- Room temperature sensor with display-Ref. 751009-

For controlling ambient temperature with automatic correction of the desired set temperature, and comfort level adjustments to be made by the user according to the room temperature.

2.5 - Initial programming

The **Thorix EVOLUTION** is pre-programmed at the factory to supply water to an underfloor circuit, controlled by a room temperature sensor.

Thorix EVOLUTION initial settings	
CIRCUIT 1 (direct circuit) Transmitters	Room temperature sensor (optional)
CIRCUIT 2 (mixed circuit) Transmitters	Underfloor circuit (with 65°C safety aquastat)
CIRCUIT 2 (mixed circuit) Room temperature monitor	Room temperature sensor (optional)

These settings enable a simplified start-up process but they can be altered to suit more complex or specific installations. These settings can be accessed through the installer menu.

2.6 - Installation recommendations

2.6.1 - Domestic hot water production linked to a heat generator

To ensure that **domestic hot water takes priority** it is possible to set an external contact input ($PAR.204 = 1$: controls when heating circuits are stopped) and connect a dry contact switch from the boiler onto the **Thorix EVOLUTION**.

If there is a domestic hot water request the dry contact opens and causes the heating circuits to stop.

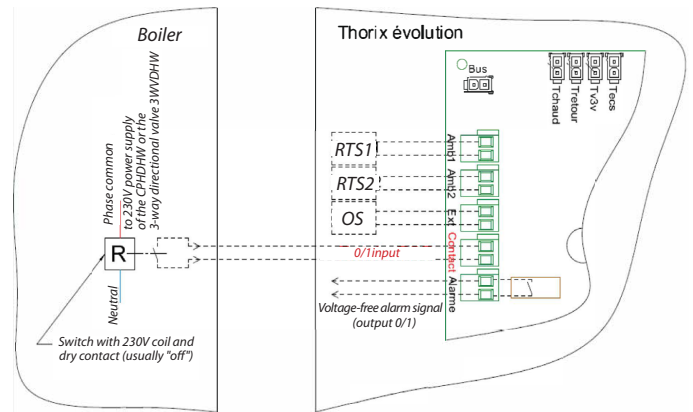

This connection is optional in cases where the generator is equipped with a 3-way valve which ensures a total switch to domestic hot water production when requested.

The underfloor heating circulator pump slows down automatically depending on the drops in pressure (max. value corresponds to $PAR.263$).

2.6.2 - Underfloor heating as circuit 2

When underfloor heating is connected to circuit 2 on the THORIX Evolution, the underfloor temperature limiter (UTL) on the THORIX **MUST** be used to monitor power supply from the heat generator.

See § "Electrical connections" for details.

2.6.3 - Direct circuit (whether or not it is registered as circuit n°1 on the THORIX)

Add a check valve (CV) to the direct circuit in order to block off any unwanted water flow generated by the underfloor heating circulator pump.

2.7 - Hydraulics diagrams

2.7.1 - Mixed circuit (circuit n°2) generator with 1 circulator pump for heating and 1 circulator pump for domestic hot water

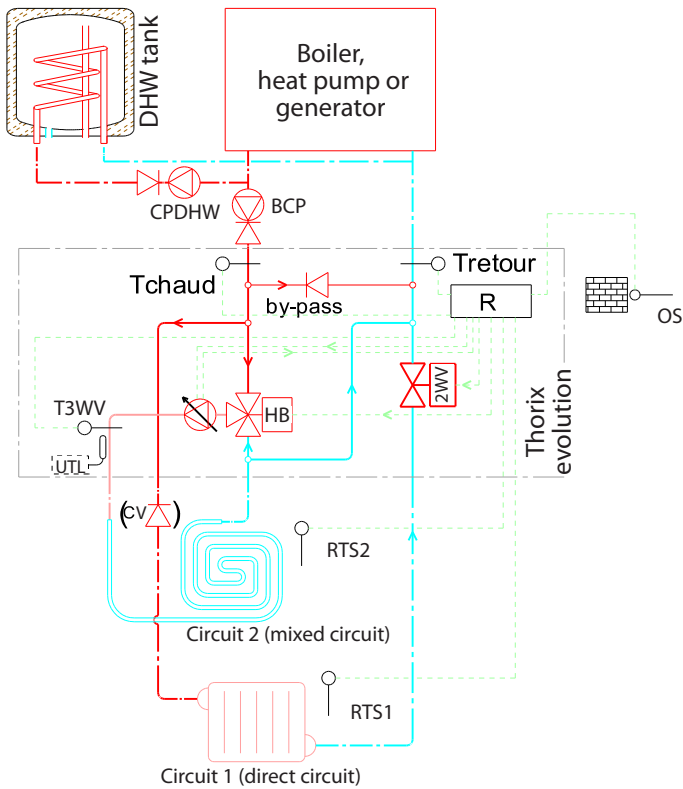

MANDATORY in cases where circuit n°2 is an underfloor heating circuit.

Make sure that the boiler's power supply passes through the underfloor temperature limiter (UTL) on the THORIX to avoid any risk of overheating in the floor (see § "Electrical connections").

Add a check valve (CV) onto the direct circuit in order to block off any unwanted water flow generated by the underfloor heating circulator pump during phases of domestic hot water production.

Activate external control of heating circuits to ensure that domestic hot water production is the top priority (see § "Electrical connections").

2.7.2 - Mixed circuit (circuit n°2) + direct circuit (circuit n°1) generator with 1 heating circulator pump and 1 3-way valve for domestic hot water

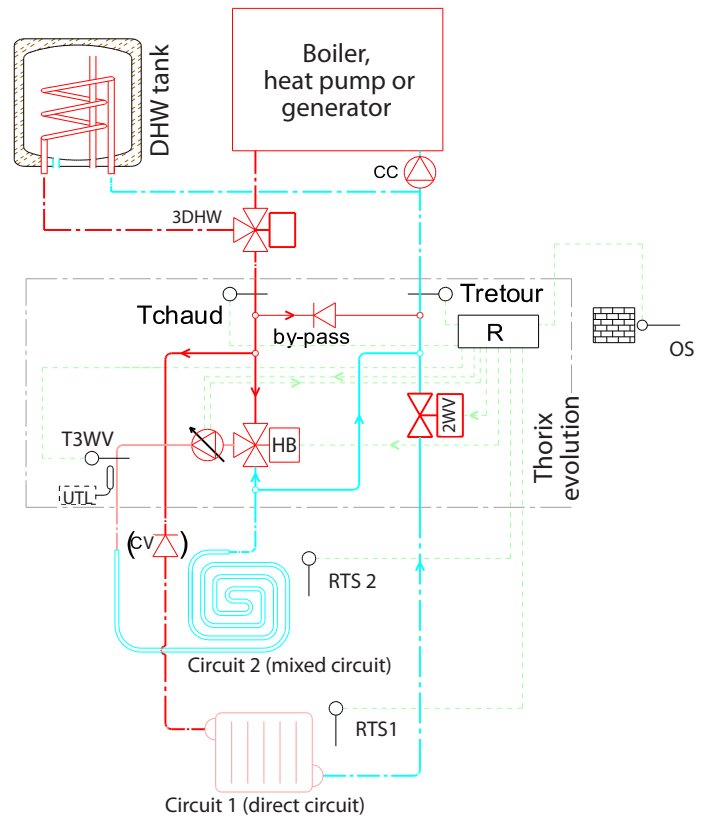

MANDATORY in cases where circuit n°2 is an underfloor heating circuit.

Make sure that the boiler's power supply passes through the underfloor temperature limiter (UTL) on the THORIX to avoid any risk of overheating in the floor (see § "Electrical connections").

Add a check valve (CV) onto the direct circuit in order to block off any unwanted water flow generated by the underfloor heating circulator pump during phases of domestic hot water production.

HB	Hydraulic block including a low-energy, variable-speed circulator pump and a motorised 3-way valve
2WV	Optional 2-way motorised valve
By-pass	By-pass with check valve
R	Electronic regulation
T3WV	Outgoing water temperature sensor 3-way valve
RT1	Circuit 1 room thermostat or room temperature sensor (compulsory if using motorised 2-way valve)
RT2	Circuit 2 room thermostat or room temperature sensor
OS	Outdoor sensor
Tboiler	Sensor for temperature provided by boiler (= outgoing to direct circuit)
Tincoming	Incoming water temperature sensor
UTL	Underfloor heating temperature limiter Limiteur de température plancher (65°C) (supplied)
BCP	Boiler circulator pump for heating
CPDHW	Boiler circulator pump for domestic hot water production
CV	Check valve for radiator circuit
3DHW	3-way valve for domestic hot water

3 - INSTALLATION

3.1 - Installation site

The **Thorix EVOLUTION** must be installed in an open space to allow the electronic components (regulation and low-energy pump) to cool down by means of natural ventilation.

The ventilation holes underneath and on top of the appliance should be left free.

The appliance must absolutely not be installed in a confined space such as a closed cupboard.

The maximum room temperature must not exceed 25 °C.

Leave a free space of 50mm on each side of the appliance so that the casing may be removed easily.

3.2 - Hydraulic connections

3.2.1 - Buffer Volume on Generator Return

To prevent the generator from overheating when the radiator(s) circuit(s) or heating floor(s) are no longer in demand (closing the thermostatic valves and/or closing the Thorix 3-way mixer valve) and in the case of installation with a generator having a low inertia (low volume of water and/or low mass) install obligatorily on the return of the generator a buffer volume sufficient and corresponding to the largest power stage of this generator.

Note: in the case of a modulating generator, the largest stage is in fact its minimum power (= 0 if 100% modulating or its minimum power «Pmini» if modulating from «Pmini» to «Pmax»).

Example 1, larger-stage electric boiler P = 4kW, operating with a differential control $\Delta T = 2^\circ K$ and for operation of a minimum duration $\Delta t = 2$ minutes, the minimum volume of the boiler and the buffer volume must be:

$$V_{\text{mini}} = \frac{P(\text{kW}) \times \Delta t}{1,16 \times \Delta T} = \frac{2(\text{kW}) \times \frac{4}{60} (\text{hour})}{1,16 \times 2^\circ(\text{K})} \times 1000 \geq 57 \text{ (liters)}$$

If the boiler contains 5 liters of water, the minimum buffer volume is 57 - 5 = 52 liters.

Example 2, gas boiler or fuel oil «Pmini» = 8 kW, operating with a differential control $\Delta T = 7^\circ K$ and for operation of a minimum duration $\Delta t = 5$ minutes, the minimum volume of the boiler and the buffer volume must be :

$$V_{\text{mini}} = \frac{P(\text{kW}) \times \Delta t}{1,16 \times \Delta T} = \frac{8(\text{kW}) \times \frac{5}{60} (\text{hour})}{1,16 \times 7^\circ(\text{K})} \times 1000 \geq 82 \text{ (liters)}$$

If the boiler contains 30 liters of water, the minimum buffer volume is 82 - 30 = 52 liters.

Example 3, Larger Power Stage of Heat Pump P = 11 kW, operating with a differential control $\Delta T = 5^\circ K$ and for operation of a minimum duration $\Delta t = 5$ minutes, the minimum volume of the heat pump and buffer volume must be :

$$V_{\text{mini}} = \frac{P(\text{kW}) \times \Delta t}{1,16 \times \Delta T} = \frac{11(\text{kW}) \times \frac{5}{60} (\text{hour})}{1,16 \times 5^\circ(\text{K})} \times 1000 \geq 158 \text{ (liters)}$$

If the heat pump contains 5 litres of water, the minimum buffer volume is 158 - 5 = 153 litres.

3.2.2 - Connecting to primary circuit and heating circuits

Connection to the primary boiler circuit and heating circuits must be made using a PEX 25 tube, a steel 3/4" tube or a copper 22-1 tube and 3/4" flat swivel joints.

3.2.3 - Characteristics of low-energy, variable-speed circulator pump

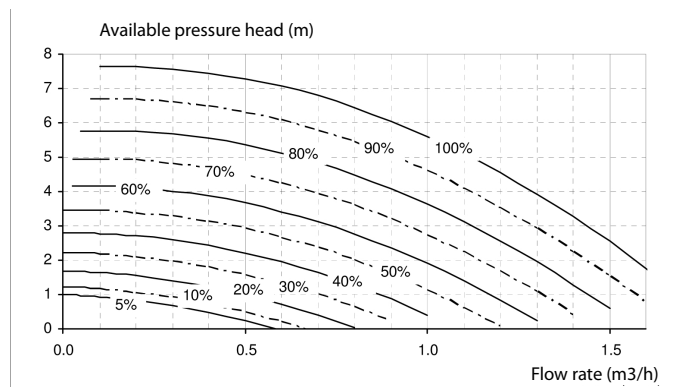

Power absorbed: 4 to 70W depending on the speed.
Input current 0.05 to 0.58A depending on the speed.

3.2.4 - Characteristics of by-pass with check valve

The maximum by-pass flow-rate depends on the manometric height which is imposed by the boiler circulator pump:

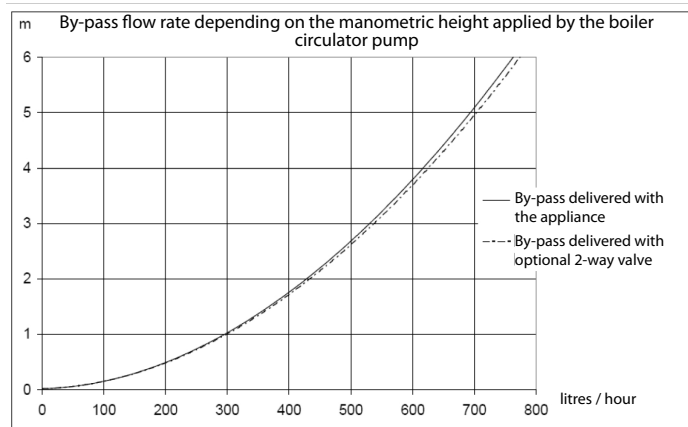

3.2.5 - Application for radiator or fan coil unit circuit(s)

To heat with radiators or fan coil units, the heating water temperature must not exceed 80°C. This limit is automatically set when the circuit selected in the "CONFIGURATION" menu is "RADIATORS".

Thermostatically-controlled valves: these valves should primarily be used on premises which benefit from a lot of free energy calories from the sun.

In an installation where all valves are thermostatically controlled, it is essential to use a bi-passage function (e.g. a differential valve).

For installations which include thermostatically-controlled valves and a room temperature control (thermostat or room temperature sensor), the premises where the room temperature control is located **MUST** have radiator(s) equipped with manual valve(s).

It is **IMPERATIVE** to refer to the installation and assembly instructions of the thermostat or the room temperature sensor to ensure that you get the best results from it.

3.2.6- Application for underfloor heating circuit(s)

For underfloor heating, the heating water temperature must not exceed 50°C. This limit must be set in the "PARAMETRES" (P252 ≤ 50°C) menu when the circuit selected in the "CONFIGURATION" menu is "UNDERFLOOR".

The mixed circuit (n° 2) is equipped with a manual reset aquastat set to 65°C at the heating circulator pump outlet.



If your second circuit is an underfloor heating circuit it is OBLIGATORY to control the power supply of the boiler from the underfloor heating temperature limiter on the Thorix EVOLUTION (see § "Electrical connections").

If circuit n°1 is also an underfloor heating circuit, it is obligatory to add another safety measure by fitting another 65°C aquastat with manual reset, which will cut off the boiler circulation pump in case of over-heating.

3.3 - Treatment of heating circuit water

3.3.1 - Preparing the hydraulic circuit

Before fitting the **Thorix EVOLUTION**, the installation must be rinsed with a suitable product.

This helps to eliminate all traces of debris such as soldering waste, joint filler, grease, mud or metallic particles in radiators, underfloor heating circuits etc.

3.3.2 - Water for filling the tank

Several different types of material are used to make a heating circuit. Instances of corrosion may occur through galvanic coupling in new and old installations alike.

The water circuit must only be filled using untreated (unsoftened) water from the drinking water circuit. If water from any other source (e.g. a well or a drill-hole) is used, the warranty will be rendered null and void.

Water filling:

Ensure that all valves are open when the heating circuit is filled with water.

3.3.3 - Heating circuit treatment

Central heating installations must be cleaned to eliminate debris (copper, fibres, soldering waste) which can come from setting up the installation or chemical reactions between metals.

Treatment products from other manufacturers may be used if they guarantee suitability to all the materials used in the installation and they offer effective corrosion resistance. In this case, please refer to their instruction manuals.

Furthermore, it is important to protect central heating installations from risks of corrosion, limescale, and microbiological development by using a corrosion inhibitor which is suitable for all types of installation (steel radiators, cast iron, PEX underfloor heating).

Products used for heating water treatment must be approved by your local or national public hygiene and health authority.

We would recommend the use of SENTINEL products for preventative and curative heating water circuit treatment.

- Fitting the appliance onto **new installations** (under 6 months) :
 - Clean the installation with an all-purpose cleaning product to eliminate installation debris (copper, fibres, soldering waste).
For example : SENTINEL X300 or SENTINEL X800.
 - Rinse the installation thoroughly until the water is clear and completely free of impurities.
 - Protect the installation from corrosion with an inhibitor, (for example *SENTINEL X100*) or from corrosion and frost with an inhibitor and an anti-freeze agent (for example *SENTINEL X500* or *SENTINEL R600*).
- Fitting the appliance onto **existing installations**:
 - De-sludge the installation with a product for eliminating sludge from the installation, for example *SENTINEL X400* or *SENTINEL X800*.
 - Rinse the installation thoroughly until the water is clear and completely free of impurities.
 - Protect the installation from corrosion with an inhibitor, (for example *SENTINEL X100*) or from corrosion and frost with an inhibitor and an anti-freeze agent (for example *SENTINEL X500* or *SENTINEL R600*).

The corrosion inhibitor:

- Limits limescale formation,
- Prevents "pinhole" corrosion,
- Prevents sludge accumulation and the spread of bacteria in new installations (algae in low-temperature circuits)
- Prevents hydrogen formation
- Eliminates noise from generators.

3.3.4 - Degassing the installation

The oxygen present in air is very corrosive. Therefore, manual or automatic degassing air valves should be fitted to each high point of the installation and manual air valves should be fitted onto each radiator to ensure a continuous degassing of the installation (see § "Purging").



INVALIDATION OF WARRANTY

Any deterioration of the appliance which is due to unsuitable filling water quality, corrosion, absence of the treatment products which are described above and / or incorrect degassing of the appliance will render the warranty null and void.

3.4 - Electrical connections

Electrical connections for the appliance must be carried out by a qualified professional with the appliance switched off from mains power.

3.4.1 - Accessing electrical connections

Remove the upper cover of the appliance and also the protective cover on the electronics board.

IMPORTANT: ALL CURRENT RULES AND REGULATIONS ON ELECTRICAL SAFETY IN YOUR COUNTRY MUST BE RESPECTED

Diagram of electrical connections for the appliance

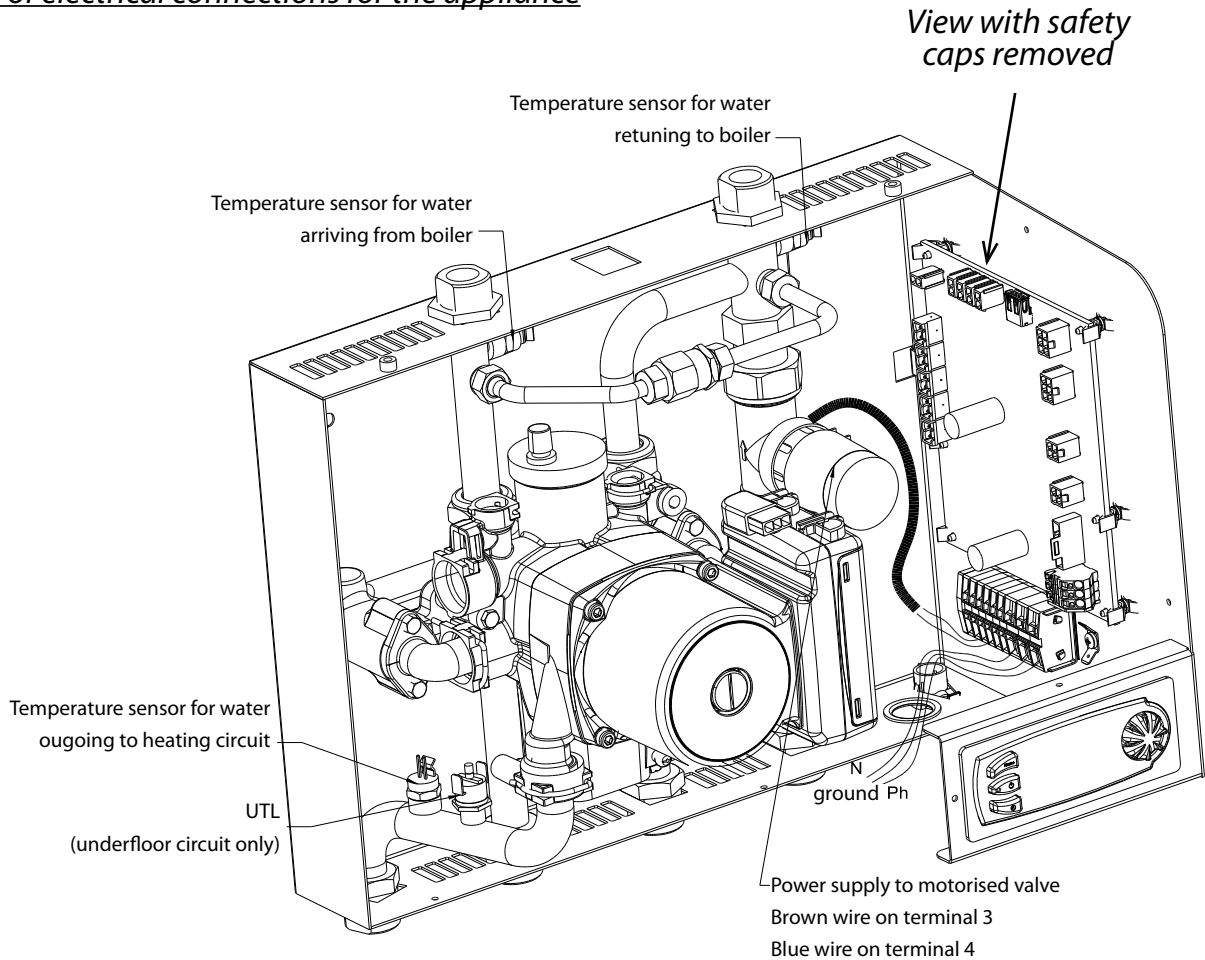

The terminal strips are spring-loaded «Cage Clamps». For handling, use a 3.5 x 0.5mm screwdriver.

- 1 : Insert the screwdriver into the flap just above or below the identification number.
- 2 : Insert the wire into the «CAGE CLAMP» when the flap is open.
- 3 : Remove the screwdriver.

Remarque :

The wires must be stripped to the following lengths between 10 et 12mm.

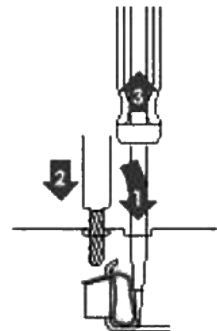

3.4.2 - Electrical diagram

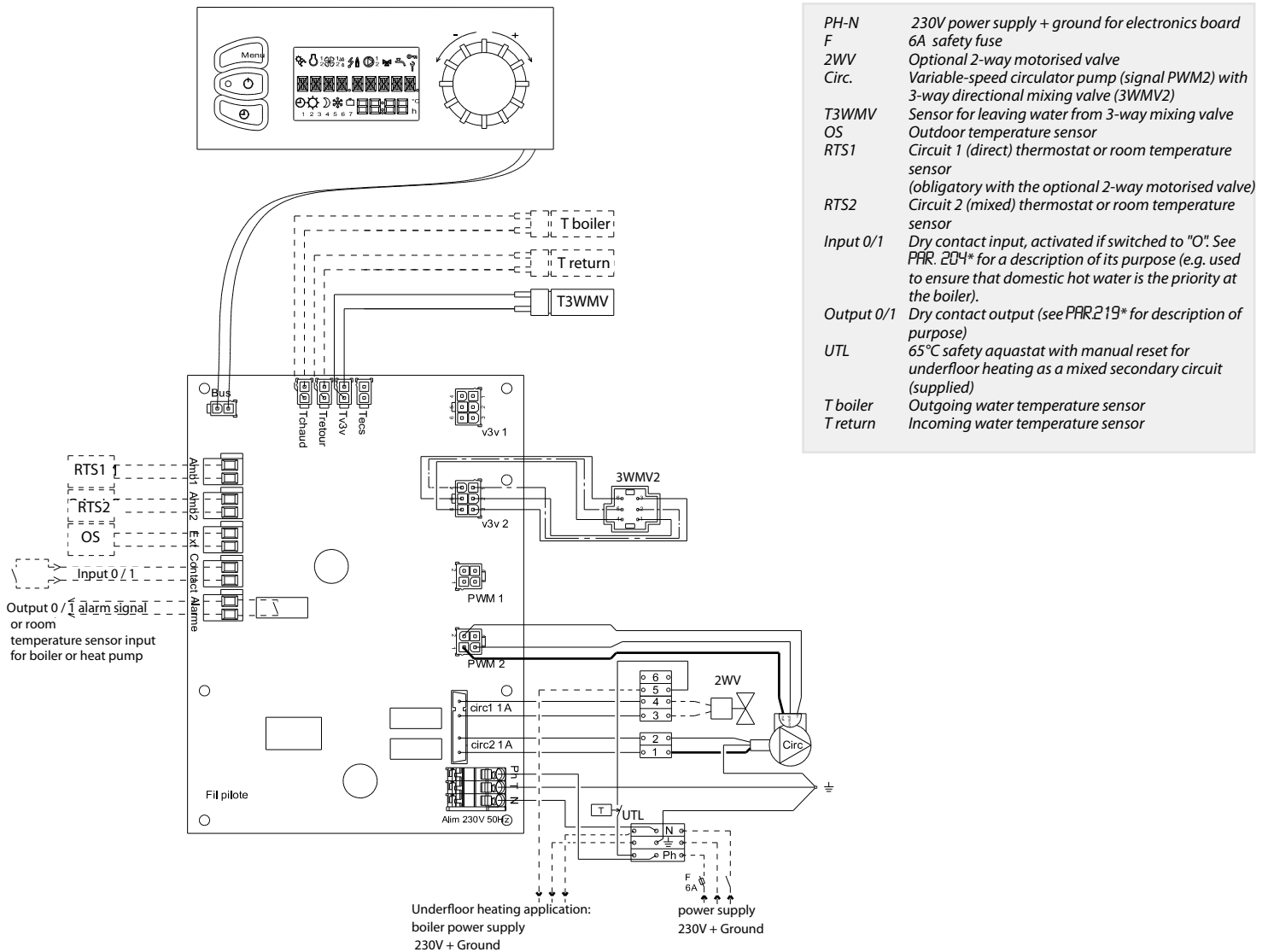

* See § "Set-up" for an explanation of parametres PAR.201 to PAR.229

3.4.3 - Power supply and electrical safety

Place a bipolar switch combined with a 6A(*) fuse (F) or a 6A (*) magnetic thermal circuit breaker on the power line of the **Thorix EVOLUTION**.

Connect the two power cables (phase and neutral) onto the two power terminals, with the ground cable on the ground terminal of the appliance.

The manufacturer is under no circumstances responsible for any consequences which may arise due to an incorrect choice of power cable section or any other lay-out or installation errors.

(*): see § "Power supply to boiler must be controlled by 65°C safety thermostat where the secondary circuit is an underfloor heating circuit."

3.4.4 - Electrical connections

The appliance is delivered from the factory fully wired. However, it is still necessary to connect to the following items to the correct terminals:

- **Amb1 (RTS1)** = Primary direct circuit room temperature sensor (Ref. 751009) or room thermostat (obligatory with the 2-way motorised valve option).

- **Amb2 (RTS2)** = secondary mixed circuit room temperature sensor (Ref. 751009) or room thermostat.

In order to obtain optimum comfort levels and to benefit from the extra functions on the appliance (overriding timer settings from a distant position, optimising the heating cycle...) we would recommend that you use the room temperature sensor (Ref. 751009).

For installations with thermostatic mixing valves and a thermostat or room temperature sensor, the premises where the thermostat or the room temperature sensor is located must have radiator(s) equipped with manual valve(s).

The ambience controller must be positioned on an inside wall of the premises which will be monitored by the appliance. It should not be positioned on a wall which leads outside on the other side.

Do not place the ambience controller too near to a window, curtain or door. Do not install it in an alcove, a cupboard or behind any kind of wall covering.

Do not place it above a heat source (e.g. radiator or fireplace) or on a wall with a fireplace behind it.

Do not place it in strong sunlight or powerful lighting.

Fit the sensor 1.50 m above the ground and at least 50 cm away from neighbouring walls. Insulate the end of the protective sheath on the electric installation on the side of the appliance to prevent any drafts that may affect temperature measurement.

To transmit an ambience request to the boiler for at least 1 heating circuit, set parametre 219 = 1 and connect the alarm signal to the room temperature sensor input on the boiler.

- **OS** = Outdoor sensor

Position the outdoor sensor on the coldest outside wall of the building (generally the north-facing wall).

It should not be exposed to morning sun.

It is preferable to fit the outdoor sensor in the middle of the building's facade or heating zone, a minimum of 2.5m above the ground.

Do not place the outdoor sensor:

- above windows, doors, air outlets or other heat sources
- under balconies or gutters.

In order to avoid errors in measurement due to air circulating, insulate the end of the electrical sheath at the sensor. Do not paint the outdoor sensor.

• A contact input or alarm signal output (see markings on electronics board):

- **Contact** = 0 / 1 input or voltage-free dry contact input. This input is activated if the contact is open (no current can pass). The purpose of the contact must be defined by *PAR.204* (for example used to prioritise domestic hot water).

- **Alarm** = 0 / 1 output or dry contact output. The purpose of the contact should be defined by *PAR.219*.

3.4.5 - Using the "outdoor temperature deduction" function

Incompatible with the activation of the stop heating function (*P204* = 1 to 3).

Using the "outdoor temperature deduction" function (*PAR.209* = YES) means that you do not need to connect an outdoor sensor to the **Thorix EVOLUTION** in cases where the boiler has an outdoor sensor and a heating curve. The **Thorix EVOLUTION** measures the temperature delivered by the boiler and deducts the outdoor temperature. This temperature is then used by the **Thorix EVOLUTION** as if it came from its own outdoor sensor.

As this function uses both the T boiler and T return sensors it is necessary to activate them (*PAR.229* = YES).

3.4.6 - Using the "heat pump de-icing assistance" function

As the "heat pump de-icing assistance" function (*PAR.264* = YES) uses both the T boiler and T return it is necessary to activate them (*PAR.229* = YES).

This function may only be activated if circuit 2 (the mixed circuit) is an underfloor circuit which is not controlled by thermostatic mixing valves or any other external control, but must be controlled by a room thermostat or room temperature sensor, as in the following circuit 2 configuration:

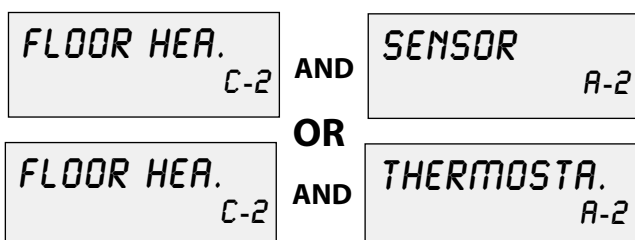

3.4.7 - Power supply to boiler controlled by 65°C safety aquastat where the secondary circuit is an underfloor heating circuit



Where circuit n°2 is a radiator circuit the power supply to the boiler must not be controlled by the 65°C cut-off underfloor temperature limiter

3.4.7.1 - Boiler with < 4A power supply



Where circuit n°2 is an underfloor circuit, to avoid any risk of overheating, the power supply of the boiler must be controlled from the underfloor temperature limiter of the Thorix EVOLUTION (see connection below)

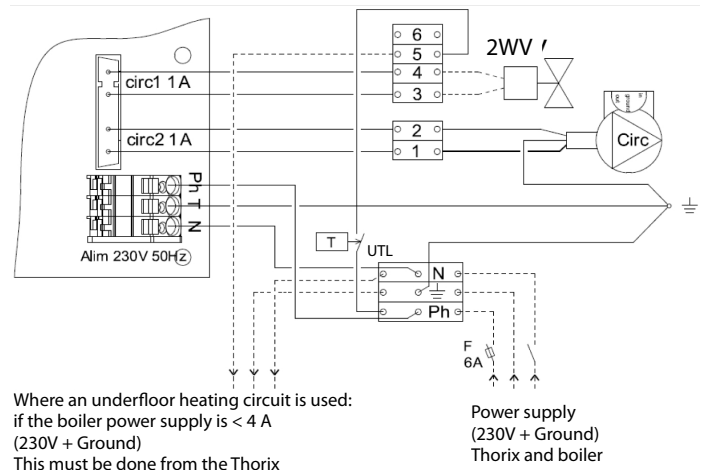

3.4.7.2 - Boiler with ≥ 4A power supply or high temperature heat pump (≥65°C) or heat pump with boiler or electrical back-up



Where circuit n°2 is an underfloor heating circuit, in order to avoid any risk of overheating, load shedding must be carried out on the boiler or heat pump using the underfloor temperature limiter of the Thorix EVOLUTION (see connection below)

Disconnect the UTL wire which is connected to the phase terminal of the **Thorix EVOLUTION** and connect it to terminal n°6. Next, connect the dry contact of the UTL (terminals 5 and 6) onto the load shedding input of the boiler or high temperature heat pump. Load shedding brings the heat generator to a complete stop.

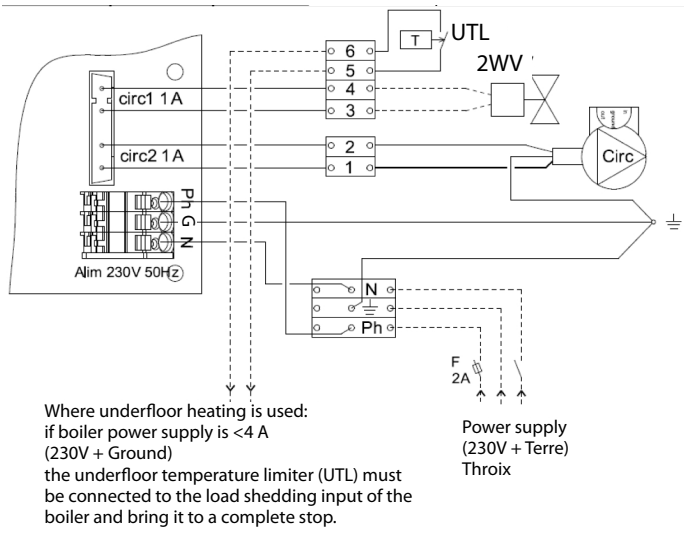

3.4.7.3 - Low temperature heat pump (< 65°C)

Load shedding is not necessary for a low temperature heat pump (with neither boiler nor electrical backup).

3.4.8 - Boiler or heat pump with 2 underfloor heating circuits

If circuit n°1 is also an underfloor circuit, extra safety measures must be taken by adding a second 65°C safety aquastat with manual reset (UTL2) which will switch off the boiler circulator pump in case of over heating.

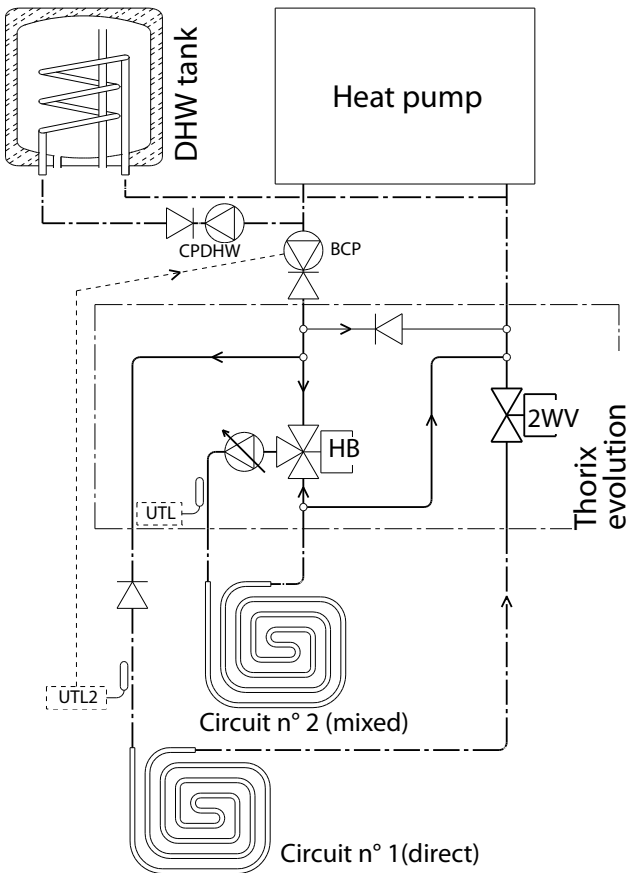

BH	Hydraulic block with low-energy, variable-speed circulator pump and a motorised 3-way valve
2WV	Optional motorised 2-way valve
3WVS	Sensor for outgoing water from 3-way mixing valve
UTL	Underfloor temperature limiter (65°C) (supplied)
BCP	Boiler circulator pump
CPDHW	Boiler circulator pump for domestic hot water
CV	Check valve for radiator circuit
UTL2	Underfloor temperature limiter (65°C) (not supplied)

4 - SET UP

- Fittings carried out on water circuits or electrical installations must conform to current regulations and be done by a qualified professional.
- Fill the installation with water.
- Purge the heating circuits (open the purgers fully until all of the air has been released).
- Check that all circuits are water / air tight.
- Check that the power supply voltage is correct on the mains disconnection switch.
- Check that all hydraulic connections have been properly tightened and that there are no leaks.
- Check that all the valves are open, that the heating circuit is filled with water and that nothing will prevent the water from circulating freely in the hydraulic circuit.
- Once the aforementioned checks have been carried out, switch the appliance on.

4.1 - Control box

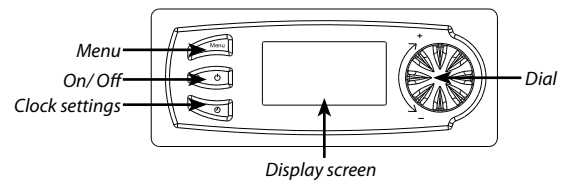

Symbols and their function:

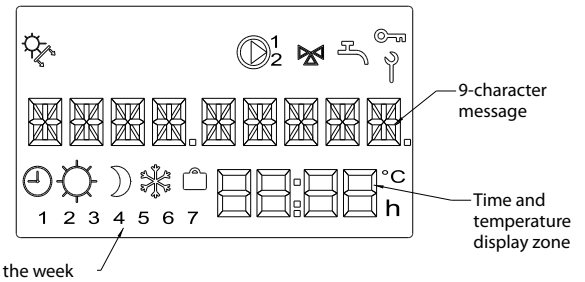

Pictograms:

- Keyboard locked
- Summer mode in progress
- Mixed circuit circulator pump operating
- Direct circuit 2-way valve open
- Adjustment/display of a setting in progress
- Adjustment of "Clock" or "Programme" in progress
- Comfort
- Economy
- Frost protection
- Holiday

Display when switched off:



Backlighting and LED light on on / off button are off.

Standard display when operating

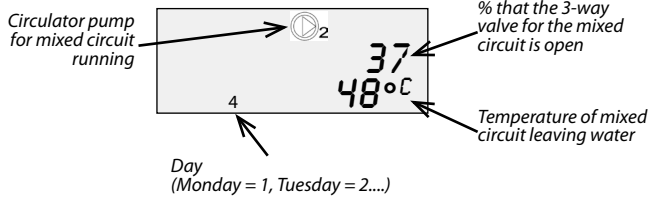

To carry out the following adjustments:

Configuration of circuit 1

(turn dial to select type of circuit) :

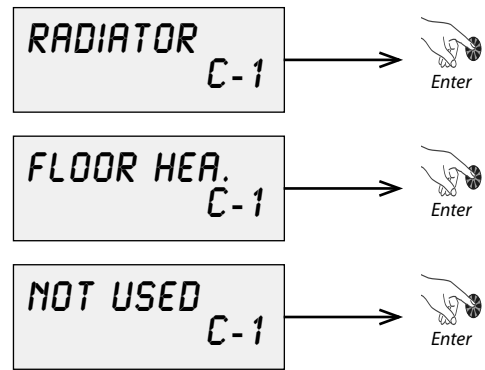

Circuit 1 ambient temperature control

(turn dial to select COMPULSORY ambient temperature control):

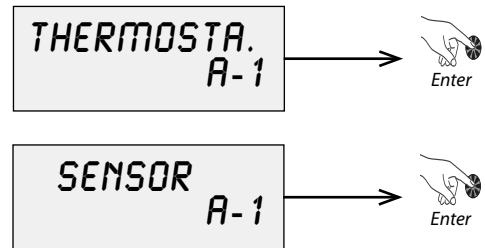

Configuration of circuit 2

(turn dial to select type of circuit) :

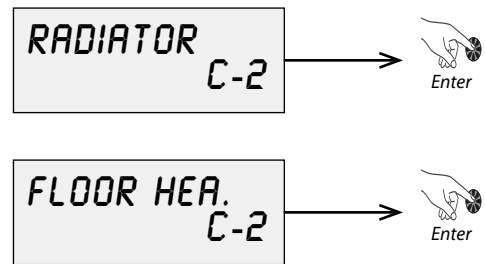

Circuit 2 ambient temperature control

(turn dial to select type of ambient temperature control or to deactivate it):

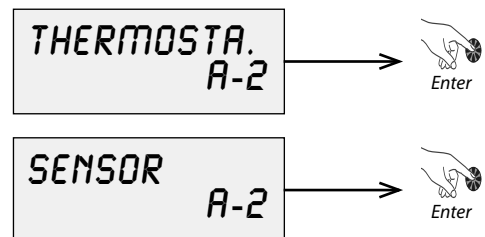

You can return to the previous screen without saving any changes by pressing at any time.

4.2 - Installer menu

Accessing the installer menu:

- Press the "Menu" button
- Turn the dial until the display shows "INST. MENU"
- Press the "clock settings" button and "Menu" button **simultaneously**
- **Keep them pressed down together** for 3 sec. to access installer menu

Turn the dial to scroll through the installer menu:

1. CONFIGURATION of the installation
2. PURGE the installation
3. TARGET for water in the mixed circuit
4. Adjusting the SETTINGS and resetting parametres
5. BALANCING (only for operation with continuous pressure drops in the mixed circuit).
6. DISPLAY of values measured
7. View COUNTERS
8. LOCK the keyboard

You can return to the previous screen without saving any changes by pressing at any time.

4.3 - Configuration of the installation

This function enables you to adapt the settings to the requirements of the circuit that the water will be supplied to. It is not necessary if the installation is in keeping with the default configuration (see § "Factory configuration").

Accessing the installer menu:

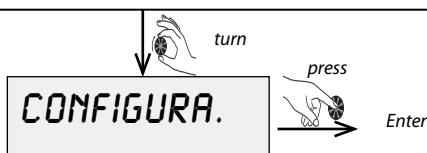

- Press the "Menu" button
- Turn the dial until the display shows "INST. MENU"
- Press the "clock settings" button and "Menu" button **simultaneously**
- **Keep them pressed down together** for 3 sec. to access installer menu



4.4 - Purging

To fully purge the installation:

Accessing the installer menu:

- Press the **"Menu"** button 
- Turn the dial until the display shows **"INST. MENU"**
- Press the **"clock settings"** button  and **"Menu"** button  **simultaneously**
- **Keep them pressed down together** for 3 sec. to access installer menu

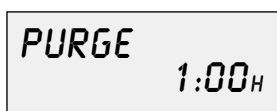

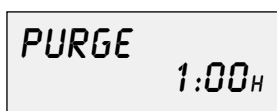
The screen will show , indicating that the circulator pump and the valves are activated and will automatically stop after an hour.

You can:

- change the circulation time period (by turning the dial to set the desired time and then pressing the dial to confirm the new setting).
- let the cycle finish automatically at the end of the time displayed.
- interrupt the cycle by pressing the "menu" button.

The mixed circuit circulator pump is equipped with an automatic air valve.



During the cycle, check that the automatic air valve and the other air valves on the installation are all properly open.

Activate the manual air valves regularly and leave open until all air has been fully purged from the circuits.

You can return to the previous screen without saving any changes by pressing  at any time.

4.5 - Manual or automatic setting on the secondary mixed circuit

Accessing the installer menu:

- Press the **"Menu"** button 
- Turn the dial until the display shows **"INST. MENU"**
- Press the **"clock settings"** button  and **"Menu"** button  **simultaneously**
- **Keep them pressed down together** for 3 sec. to access installer menu

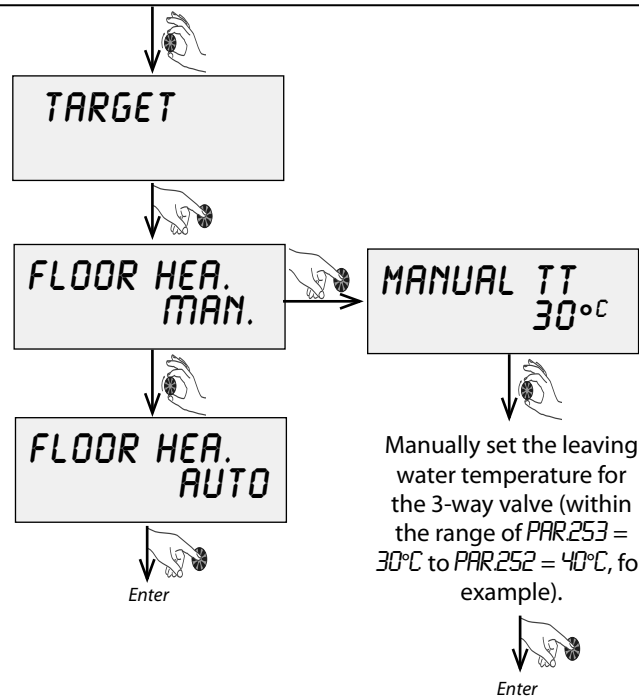

You can return to the previous screen without saving any changes by pressing  at any time.

4.6 - Settings

4.6.1 - General parametres

P201 - An outside sensor is connected to the **Thorix EVOLUTION**

P202 - Maximum outside temperature (MOT)

P203 - Minimum outside temperature (MiOT)

P204 - External contact

The external contact input can be used:

- to temporarily stop the **Thorix EVOLUTION**

in accordance with an external regulation:

- 1) if **P204** = 0, the input is deactivated
- 2) if **P204** = 1, heating is stopped
(for example hot water takes priority at the boiler)

the following message is displayed:

STOP HEAT.
20.0°C

- 3) if **P204** = 2, reduced "eco" function on mixed circuit
 - 4) if **P204** = 3, reduced "frost protection" function on mixed circuit
 - 5) **P204** = 4, not used
- P205** - not used
P206 - not used

Caution: this function is incompatible with the function «deduction of external temperature» (P209)

P207 - Summer /winter time delay (there will be a period of waiting time to ensure that the temperature change is not temporary and warrants the change in operating mode)

P208 - Heating advance: the heating advance is a learning function by the clock / timer for any switch in mode from "Frost protection" or "Holiday" to "Comfort" level.

This function needs an ambient temperature controller in zone 1 or 2.

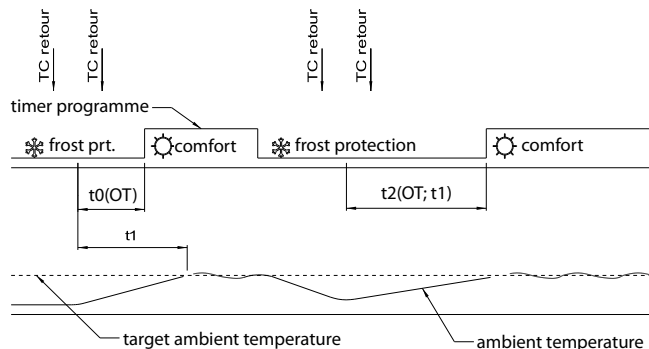

The initial heating advance = $t_0 = 4$ hours in the underfloor heating circuit and 45 minutes in modulated radiators, depending on the outdoor temperature (OT).

Successive heating advance periods are calculated using the following formula: $t_2 = t_1 \times (P202 - P203) / (P202 - \text{Text}) \leq 12$ hours

P209 - Incompatible with the activation of the stop heating function ($P204 = 1$ to 3).

The "outdoor temperature deduction" function means that the outdoor sensor on the **Thorix EVOLUTION** does not need to be connected when the boiler has an outdoor sensor and a heating curve. The **Thorix EVOLUTION** measures the temperature delivered by the boiler and deducts the outdoor temperature from it. This temperature is then used by the **Thorix EVOLUTION** as if it came from its own outdoor sensor.

The automatic summer / winter switch is no longer valid.

The following parametres must be filled in:

P210 - Generator maximum target temperature(GMa TT)

P211 - Generator minimum target temperature(GMiTT)

P212 - Generator maximum outside temperature(GMaOT)

P213 - Generator minimum outside temperature(GMiOT)

You can return to the previous screen without saving any changes by pressing  at any time.

The outside temperature is deducted from the temperature read by the "T chaud" sensor, as in the following example:

P212	P213	P210	P211
GMOT	GMiOT	GMOT	GMiOT
20	-10	80	25
°C	°C	°C	°C

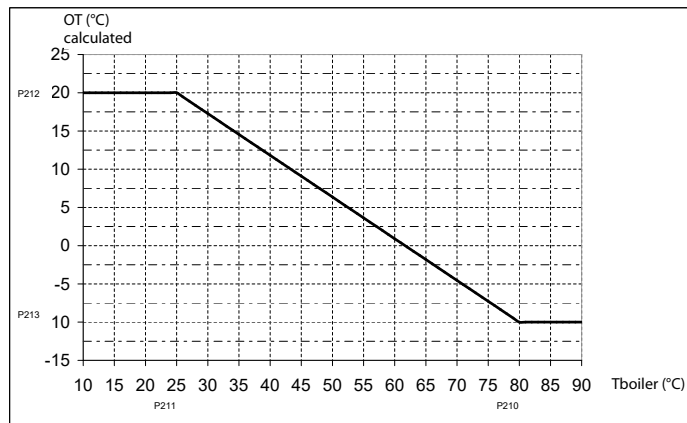

The target temperature for the leaving water from the 3-way valve is deducted from the temperature read by the "T boiler" sensor:

P202	P203	P252	P253
MOT	MiOT	MOT1	MiOT1
20	-5	40	25
°C	°C	°C	°C

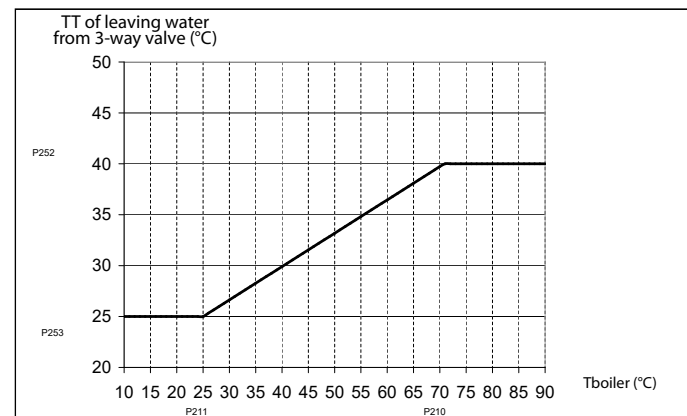

P219 - Purpose of the voltage-free alarm signal:

The voltage-free alarm signal can be used:

- to signal the appearance of an error on the **Thorix EVOLUTION** to an external control
- to transmit a heating request to the boiler from at least one heating circuit. Connect the alarm signal to the room thermostat input on the boiler.

P229 - Activation of leaving and return flow sensors on the boiler which are essential for using the following functions:

- **P209** = yes = activation of the "outside temperature deduction" function
- **P264** = yes = activation of the "heat pump de-icing assistance" function.



The boiler should be left running at all times to ensure that requests for frost protection from the Thorix EVOLUTION can be met. Set the alarm signal to P219 = 1 = "heating request" and connect the alarm signal to the boiler's room thermostat input.

Parametres	Display	Name	Unit	Range	No setting	Factory setting
P201		Outside sensor		YES : NO		NO
P202		Maximum outside temperature (MOT)	°C	11 to 25	1	20
P203		Minimum outside temperature (MiOT)	°C	-30 to 10	1	-05
P204		Effect of external contact signal Incompatible with the function «deduction of external temperature» (P209)		0 : without	1	0
				1 : heating stopped		
				2 : economy mode heating		
				3 : frost protection mode heating		
				4 : not used		
P207		Time delay for summer / winter heating mode change	hour	0 to 48	1	12
P208		Heating advance		YES : NO		NO
P209	if P229 = YES and if P201 = NO	Activation of the function deducting the outside temperature. Incompatible with the stop heating function (P204)		YES : NO		NO
P210	if P209 = YES	Generator maximum target temperature	°C	P211 to 80	1	80
P211	if P209 = YES	Generator minimum target temperature	°C	20 to P210	1	25
P212	if P209 = YES	Generator maximum outside temperature (GMOT)	°C	11 to 25	1	20
P213	if P209 = YES	Generator minimum outside temperature (GMiOT)	°C	-30 to 10	1	-05
P219		Choose purpose of alarm signal		0 : alarm		0
				1 : heating request		
P229		Activation of leaving and incoming water sensors on boiler		YES : NO		NO

 = • Go into the adjustments for the setting
• Confirm the adjustments made to the setting

 = • choose the parametre
• Change parametre

4.6.2 - Circuit 1 (direct) control

No parameters are available for Circuit 1.

It is compulsory to connect a thermostat or a room temperature sensor.

Results of programming and of the room thermostat:

Activation of timer/holiday/frost protection programming		Result of room temperature control device	
Programme status	Result of programming on water temperature	Result of room temperature thermostat on the 2-way valve for:	Result of room temperature sensor on 2-way valve for:
Comfort	no	Comfort mode	Comfort mode
Eco			Economy mode
Frost protection			Frost protection mode

4.6.3 - Circuit 2 (mixed) control

P250 - Speed modulation for circuit 2

See § "Adjusting flow rates" for an explanation of how the appliance operates depending on parameter *P250*.

- *P250* = 0 = Constant speed
- *P250* = 1 = Constant flow rate
- *P250* = 2 = Constant pressure drops

Parameters	Display	Name	Unit	Range	No setting	Factory setting
<i>P250</i>		Speed modulation for circuit 2 (mixed)		0: no (fixed speed)	1	0
				1: constant flow rate		
				2: constant pressure losses		
<i>P251</i>		Manual or automatic target temperature circuit 2 (mixed)		AUTO : MAN.		MAN.
<i>P252</i>	If <i>P251</i> = AUTO	Max. target temperature for leaving water from 3-way valve (MaTT2)	°C	<i>P253</i> to 80	1	50
<i>P253</i>	If <i>P251</i> = AUTO	Min. target temperature for leaving water from 3-way valve (MiTT2)	°C	21 to <i>P252</i>	1	30
<i>P254</i>		Circuit 2 (mixed) pump control		0: permanent	1	0
				1: depends on room thermostat		
				2: depends on room thermostat + special operation when room is at target temperature		
<i>P255</i>	If <i>P254</i> = 2	Offset of target temperature for special operation	°K	0 to 30	1	10
<i>P256</i>		Lowering of heating curve or of reference target temperature when circuit 2 (mixed) set to Eco	°K	0 to <i>P257</i>	1	10
<i>P257</i>		Lowering of heating curve or of reference target temperature when circuit 2 (mixed) set to frost protection	°K	<i>P256</i> to 40	1	20
<i>P258</i>	Only with room thermostat or room temperature sensor	Low speed (24-hr cycle) auto-adaptability for circuit 2 (mixed) if <i>P254</i> = 2	N/A	YES : NO		NO
<i>P260</i>	If <i>P250</i> = 0 (Fixed speed)	Adjustment of circulation speed for circuit 2 (mixed)	%	5 to 100	5	100
<i>P261</i>	If <i>P250</i> = 1 (constant flow rate)	Target temperature in circuit 2 (mixed)	m ³ /h	0 to 4	0.1	0.4
<i>P262</i>	If <i>P250</i> = 2 (Constant pressure losses)	Pressure loss target temperature in circuit 2 (mixed)	mCE	0 to 10	0.1	3
<i>P263</i>	If <i>P250</i> = 0 or 1 (Fixed speed or constant pressure losses)	Max. pressure loss in circuit 2 (mixed)	mCE			6
<i>P264</i>	If circuit 2 (mixed) = underfloor	Activation of de-icing assistance for heat pump		YES: NO		NO
<i>P265</i>	If <i>P264</i> = YES	Differential initiation of assistance for defrosting	°K	0 to 20	1	2
<i>P266</i>	If <i>P251</i> = MANU	Manual setpoint	°C	<i>P253</i> to <i>P252</i>	1	<i>P253</i>
<i>P267</i>		Minimum 3-way valve modulation position	%	0 to 50%	5	0

4.6.3.1 - Circuit 2 (mixed) heating curve

Example of heating curves with the parameters below:

P202	P203	P252	P253	P255	P256	P257
Max. OT MaOT	Min. OT MiOT	Max. WT MaWT	Min. WT MiWT	TT lower: no heating request	TT lower: eco mode	TT lower: frost protection
20	-10	50	30	4	7	14

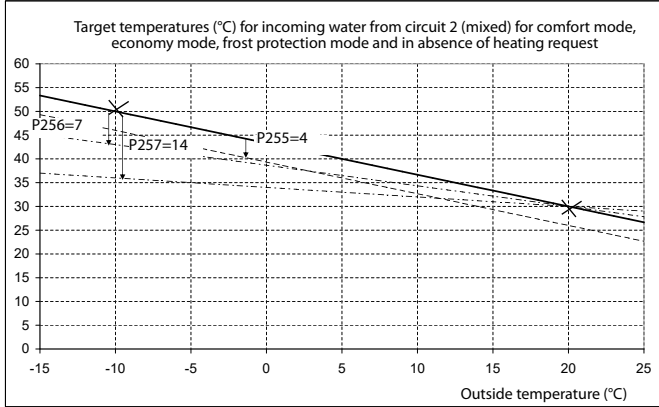

4.6.3.2 - Heat pump de-icing assistance

The thermal inertia of the underfloor heating circuit is used to serve as the heat reserve which is needed for the de-icing cycles.

P264 - Yes, possible if P229 = yes = boiler leaving and return water temperature sensors are activated.

The "heat pump de-icing assistance" function is only possible **when there is an underfloor heating circuit** on the mixed circuit **controlled by a thermostat or room temperature sensor** (no thermostatic mixing valves).

P265 - Difference in temperature required to activate the heat pump de-icing assistance (between 0 and 20°K, with default value of 2°K).

As soon as the heat pump begins a de-icing cycle it is detected by the two temperature sensors:

- if T boiler < 25°C and if T boiler < T return - P265 (~ 2°K) or if T boiler < 18 °C, the 3-way valve opens.
- if T boiler ≥ 25.5°C and if T boiler ≥ T return + P265 (~ 2°K) the leaving water target temperature for the 3-way valve becomes the normal temperature established for the heating again.

4.6.3.3 - Minimum position of 3-way valve modulation

When the generator circulator is too powerful, a whistling noise may occur when the 3-way valve is slightly open.

Set P267 to 5 or 10%.

4.7 - Adjusting flow rates ("Balancing" function)

The Circuit 2 (mixed) flow rate should be adapted depending on its use.

The flow rate is determined depending on the heating capacity and the difference in the desired temperature.

1. Operating at a fixed speed for the mixed circuit

This is the default operating mode with P250 = 0

The speed can be fixed using P260 (max. speed = 100 % by default).

Note: Max. pressure drop can be fixed using P263 (max. pressure drop = 6m by default).

2. Operating at a constant flow rate for the mixed circuit

Set parametre P250 = 1

The flow rate can be adjusted using P261 (0.4 m³/h by default).

Note: Max. pressure drop can be fixed using P263 (max. pressure drop = 6m by default).

3. Operating with constant pressure losses for mixed circuit

Set parametre P250 = 2

The drop in pressure can be fixed using P262 (3m by default).

This function allows the system to operate with constant pressure drops by varying the circulator pump speed.

Check that all valves and all thermostatic mixing valves are fully open on the mixed circuit:



P250 = 2

MANDATORY

Accessing the installer menu:

- Press the "Menu" button
- Turn the dial until the display shows "INST. MENU"
- Press the "clock settings" button and "Menu" button **simultaneously**
- **Keep them pressed down together** for 3 sec. to access installer menu

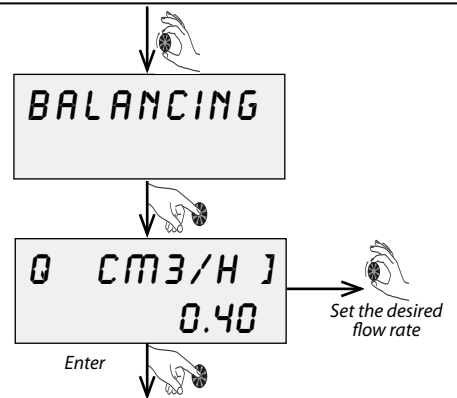

4.9 - Display

See § "Repairs": "accessing temperature measurements and information on circulator pumps and 3-way valves".

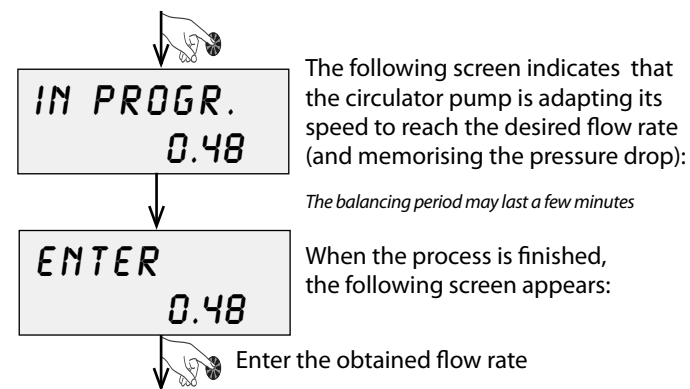



(this flow rate may differ from the desired flow rate because the circulator pump speed variation is not continuous, but adjusts gradually in stages of 10%).

You can return to the previous screen without saving any changes by pressing  at any time.

4.8 - Resetting installer parametres

Accessing the installer menu:

- Press the "Menu" button 
- Turn the dial until the display shows "INST. MENU"
- Press the "clock settings" button  and "Menu" button  **simultaneously**
- **Keep them pressed down together** for 3 sec. to access installer menu

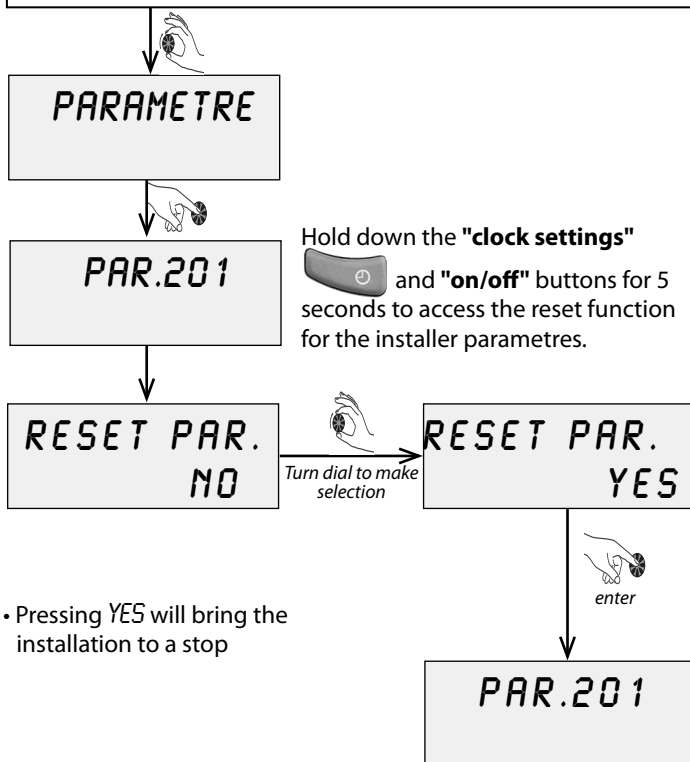

- Pressing YES will bring the installation to a stop

You can return to the previous screen without saving any changes by pressing  at any time.

5 - USE

5.1 - Setting the date and time

• Press "clock settings" 

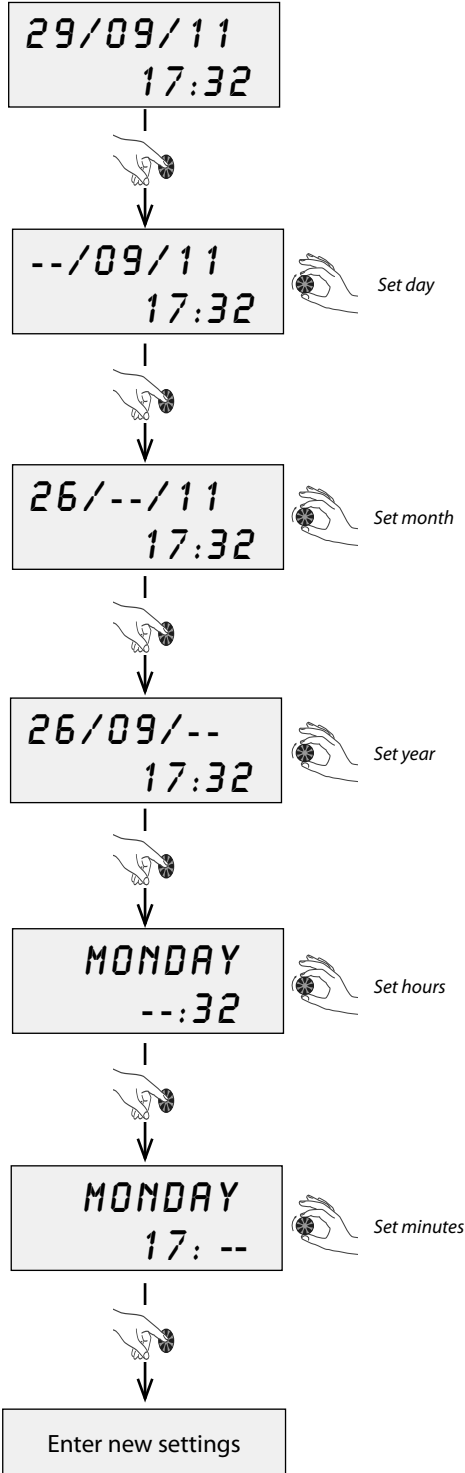





You can return to the previous screen without saving any changes by pressing  at any time.

i **N.B.:** If no adjustments are made, the screen will go back to standard display without backlighting after a few minutes

5.2 - Programming heating mode time periods

Time periods at different comfort levels can be programmed for each day and each circuit. The installation will automatically follow the programmed levels.

- Press "clock settings"  (3 sec.),
- The screen will display ,
- When the  symbol disappears, release the "clock settings"  button
- Turn the dial to select the circuit you wish to programme. (if there is only one circuit, go straight to the day you wish to programme for).

CIRCUIT 1

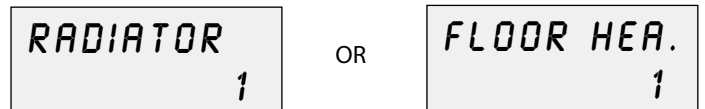

Display, depending on chosen configuration.

CIRCUIT 2

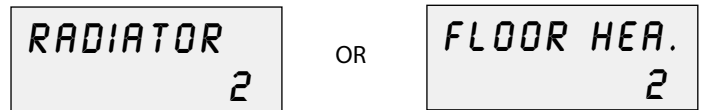

Both circuits at the same time:

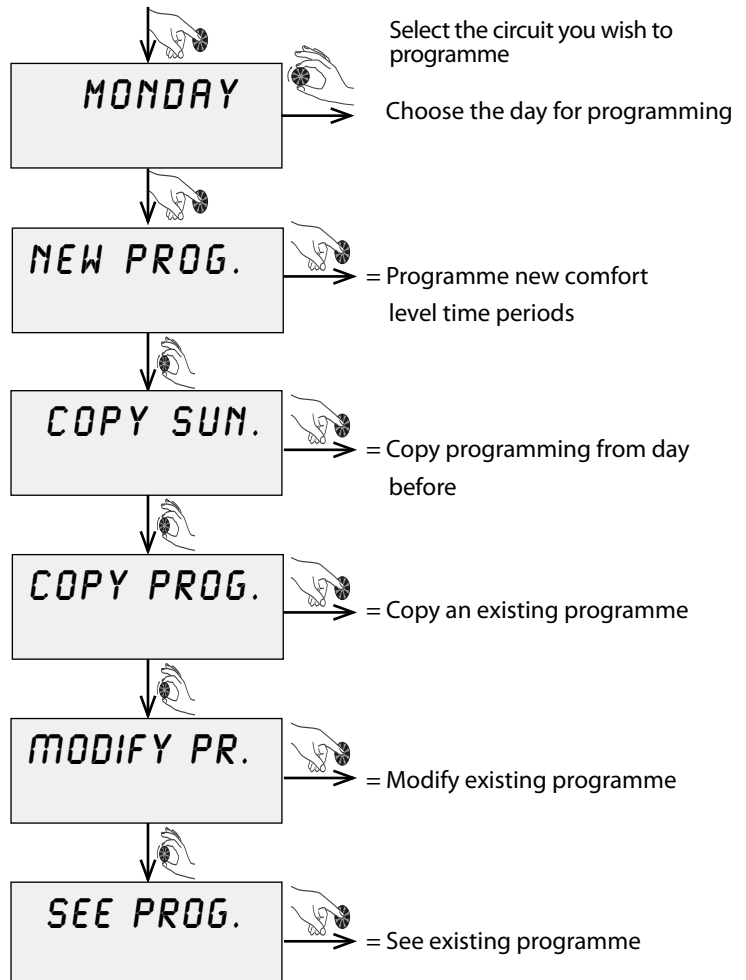

5.2.1 - Creating a new programme

Example: a programme created for a Monday

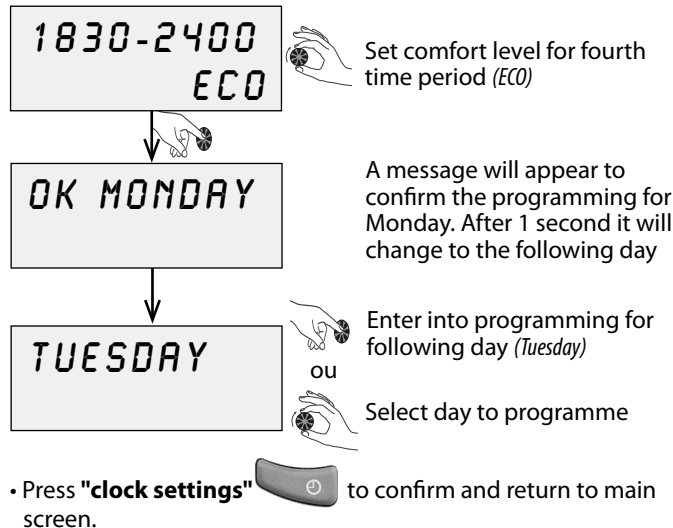
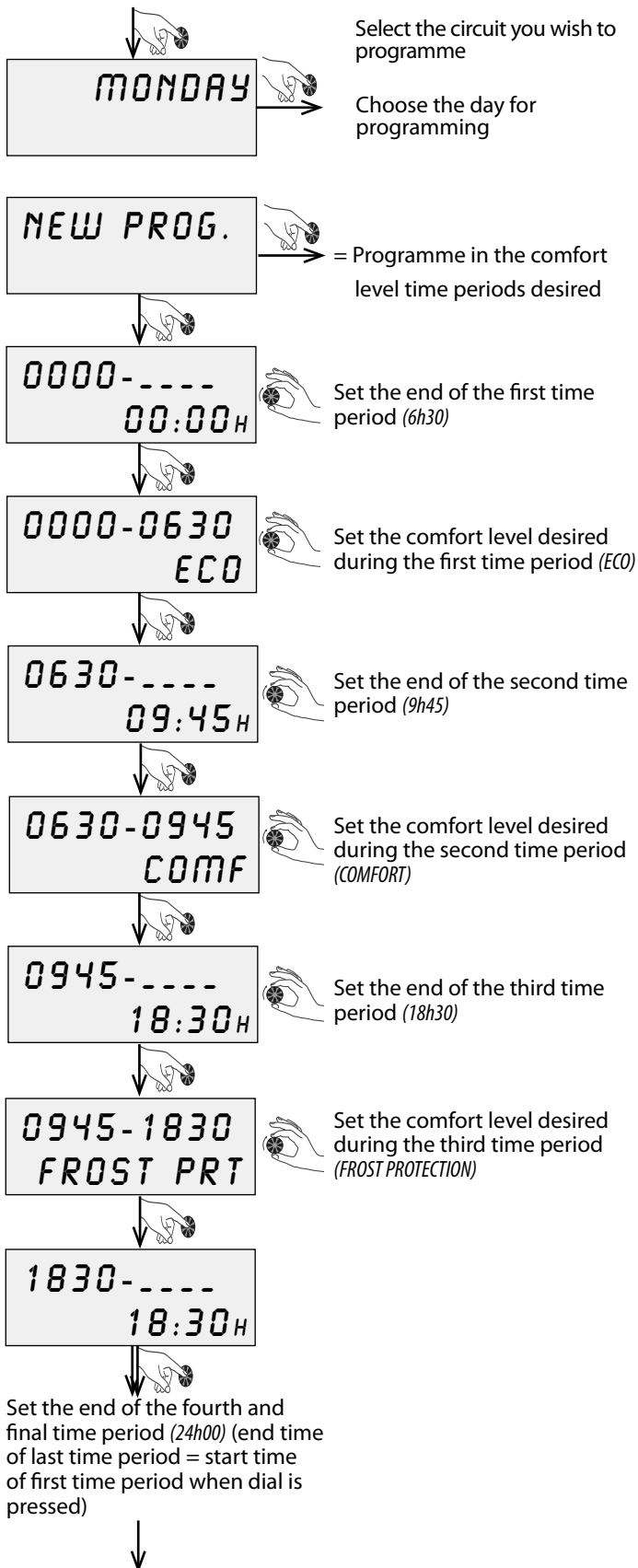
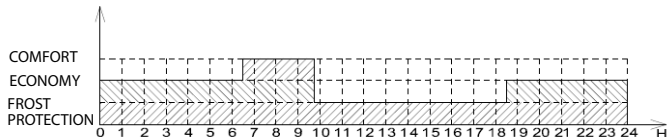

5.2.2 - Copying existing programmes

5.2.2.1 - Copying programme from day before

Example: Copying Monday's programme for Tuesday

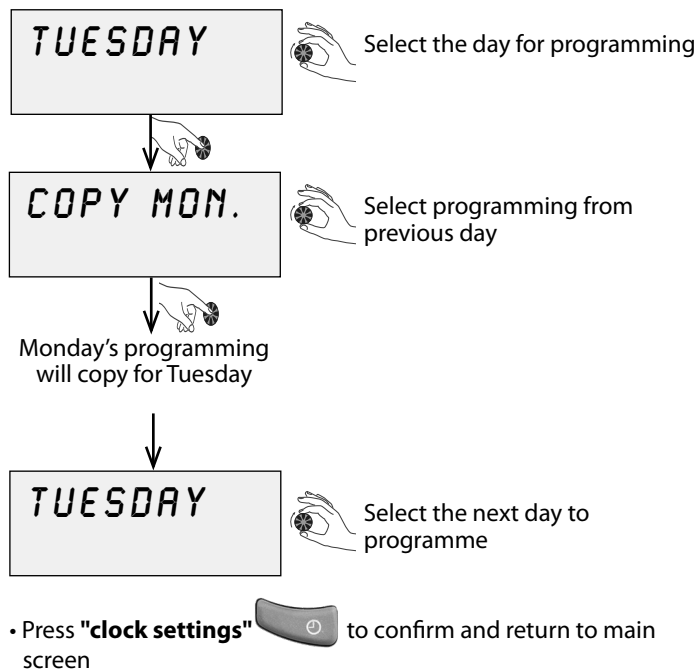

5.2.2.2 - Copying a pre-recorded programme

For example: Programme 1 to copy for Tuesday

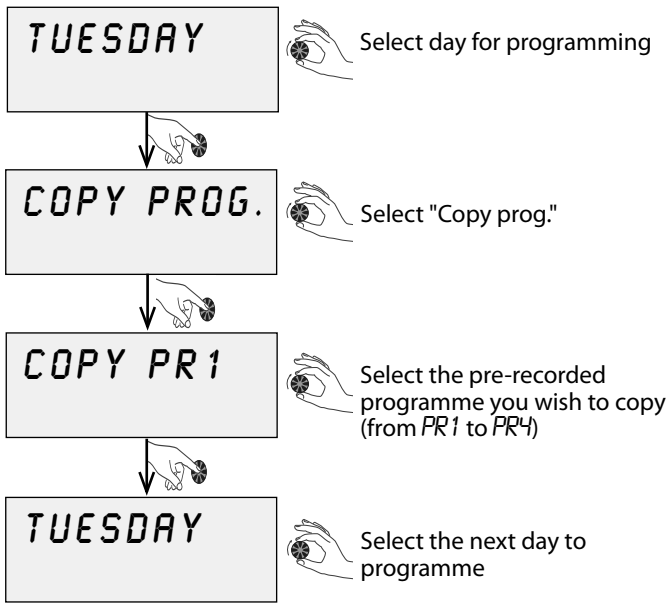

Pre-recorded programmes, PR1 to PR4

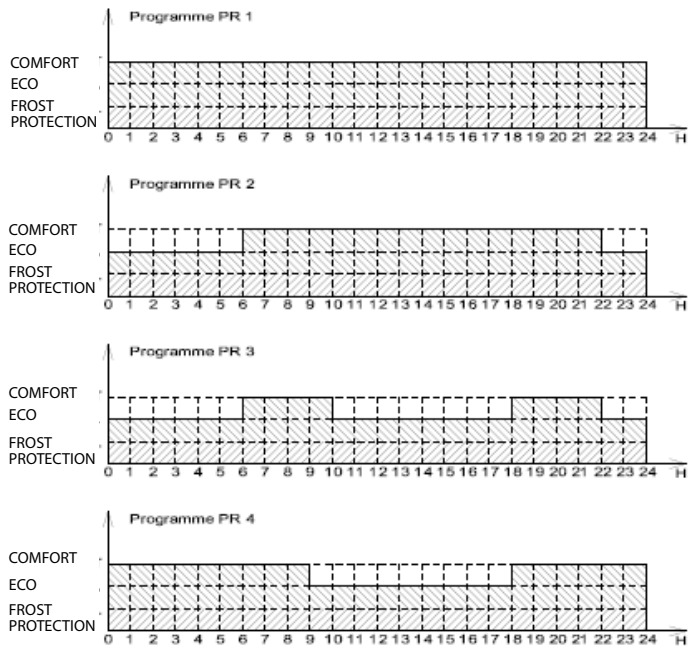

• Press "clock settings"  to confirm and return to main screen.

5.2.3 - Modifying a programme

Example: modifying Monday's programming.

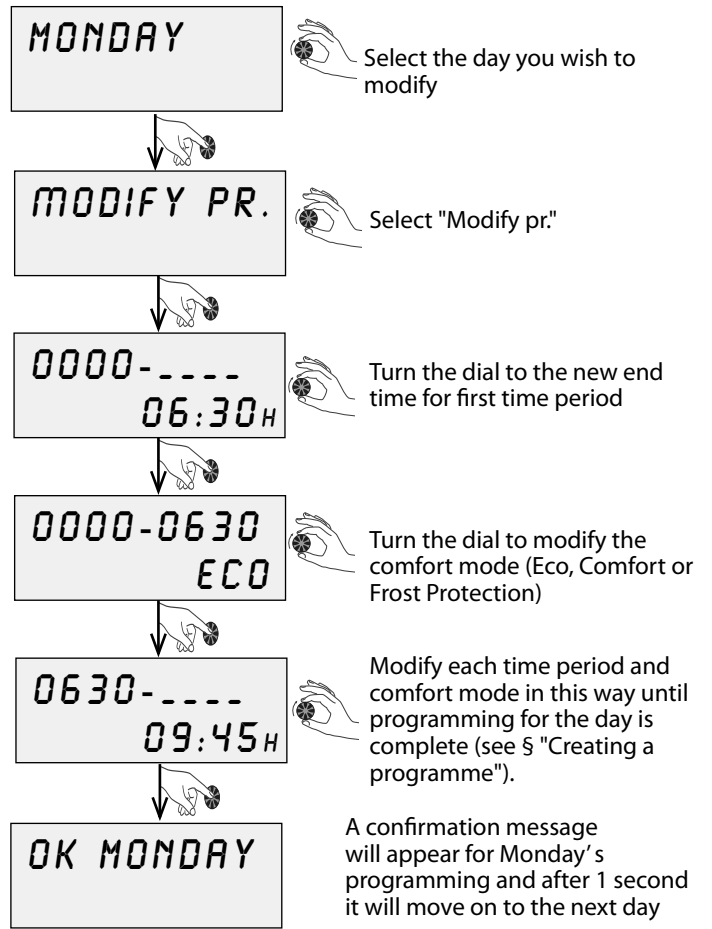

• Press "clock settings"  to confirm and return to main screen.

5.2.4 - View programme

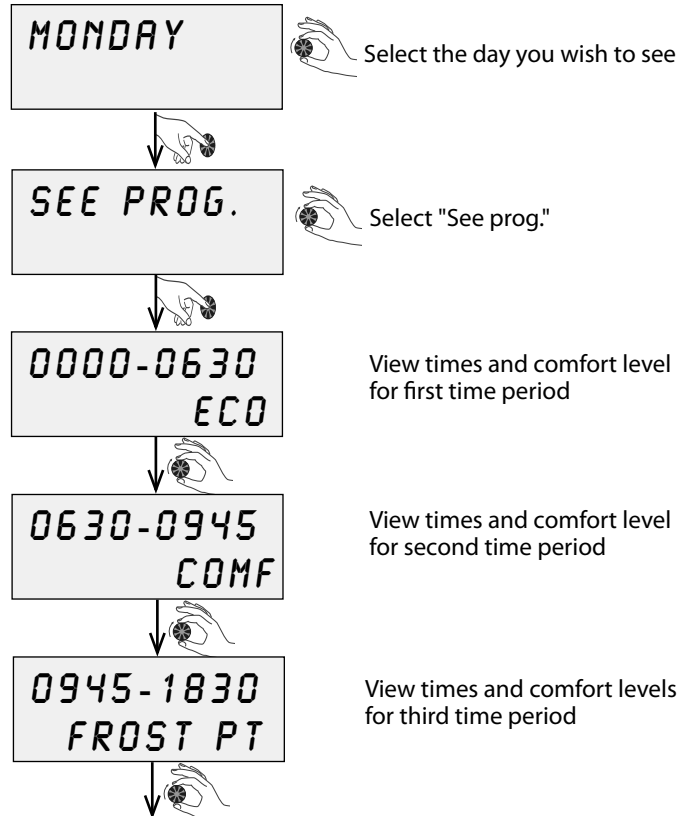

1830-2400
ECO

View times and comfort level for fourth time period

MONDAY

• Press "clock settings"  to confirm and return to main screen

5.3 - User Menu

5.3.1 - Adjusting target temperatures for Circuit 1 (direct) and Circuit 2 (mixed)

 **Can only be done with room temperature sensors**

5.3.1.1 - Setting ambient temperature 1 or 2

• Press  : the following screen will appear:

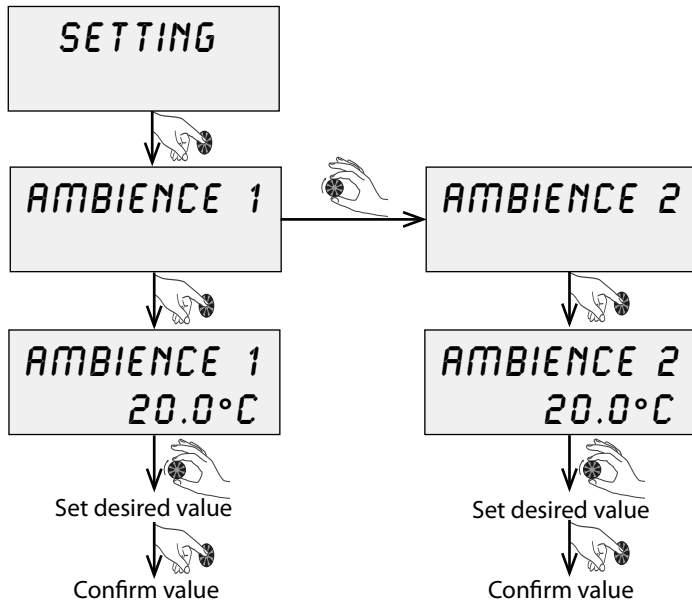

Press  at any time to go back to previous screen without saving any changes.

5.3.1.2 - Setting Ambient Temperature ECO 1 or 2

• Press  : the following screen will appear :

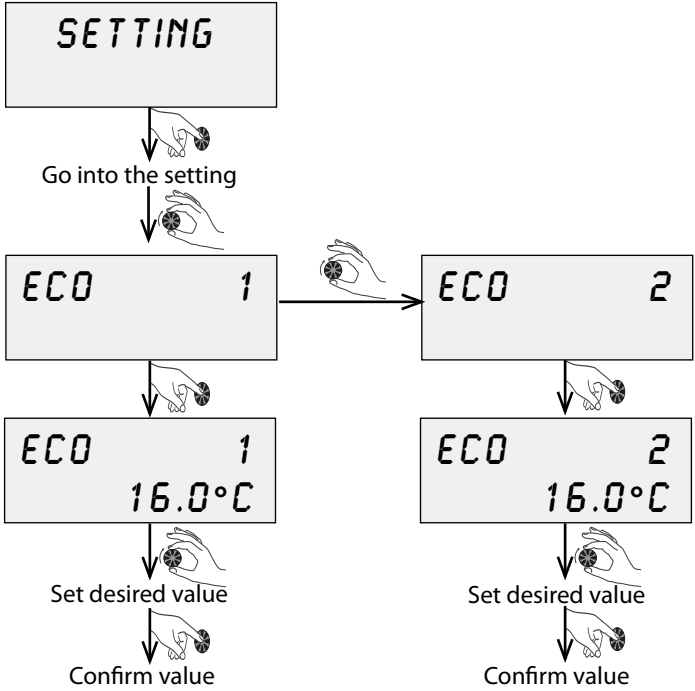

Press  at any time to go back to previous screen without saving any changes.

5.3.1.3 - Setting Ambient Temperature FROST PROTECTION 1 or 2

• Press  : the following screen will appear:

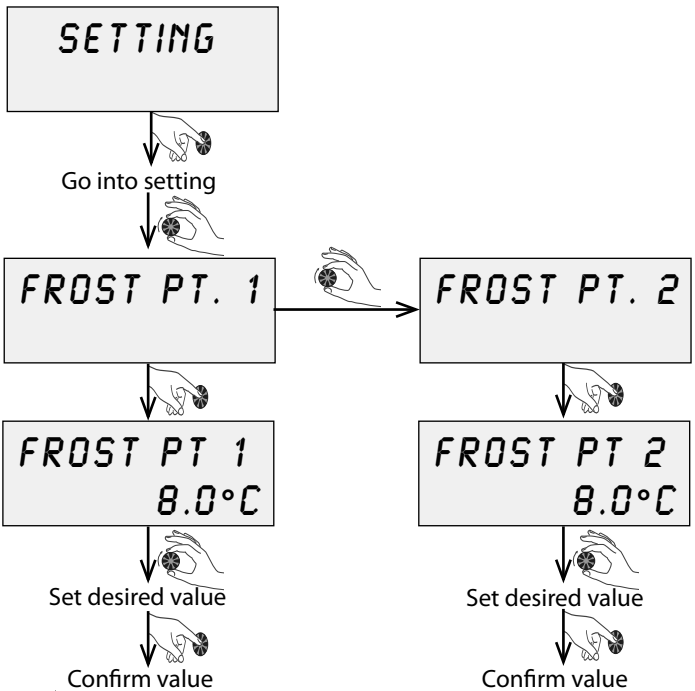

 **The boiler MUST remain in holiday mode or frost protection mode (with circulator pump running)**

Press  at any time to return to previous screen without saving any changes.

5.3.2 - Setting a holiday period

Holiday mode puts the appliance on standby whilst the freeze protection mode remains active during longer absences and allows you to programme in the day when you wish to return to normal comfort mode. This means that normal comfort mode can be resumed before you return to your residence. This function can be programmed to run between 1 and 99 days and is effective as soon as the number of days has been confirmed.

! The boiler MUST remain in holiday or frost protection mode (with the boiler circulator pump running). The boiler must also provide frost protection for the Circuit 1 (direct) water circuit.

- Press 
- Turn the dial to access the setting:

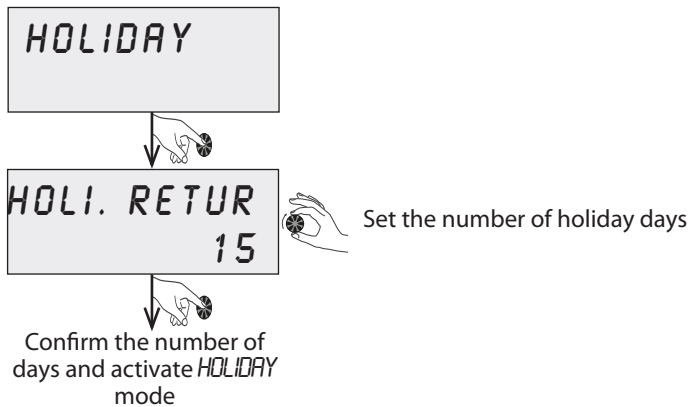

- Press  to return to screen which displays:



The number of days left will be counted down every day.

HOLIDAY mode will come to an end automatically at the end of the programmed time period. The time period can be changed or stopped while the mode is in progress.

5.3.3 - Stopping the Thorix EVOLUTION

! The boiler MUST remain in holiday or frost protection mode (with the boiler circulator pump running). The boiler must also provide frost protection for the Circuit 1 (direct) water circuit.

! The P219 = 1 = "heating request" alarm signal must be set and the alarm signal must be connected to the boiler's room-thermostat input (see § "Settings" and "Electrical connections" in order for the boiler to run when there are requests from sensors or room thermostats in frost protection mode.

5.3.4 - Temporary override of set comfort mode by programming a time period

The programmed comfort level can be overridden, for example in cases where someone is at home outside of the usual time periods.

- Press 
- Turn the dial to access the setting:

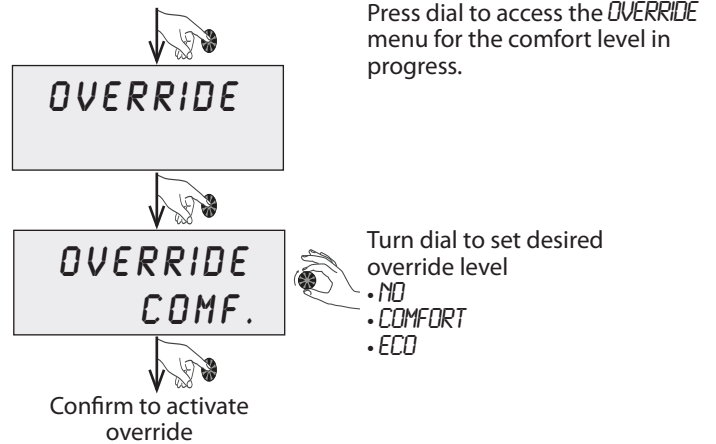

i N.B:

- Overriding a comfort mode will apply to all circuits which are running
- The override will end at the beginning of the next cycle with the same comfort level:

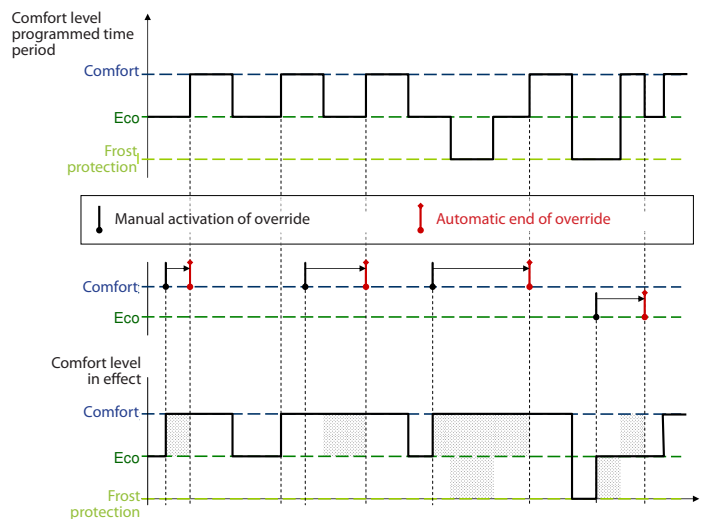

- Press  at any time to return to previous screen without saving any changes.

5.3.5 - Selecting summer / winter modes

The *SUMMER/WINTER* sub-menu enables you to manually change:

- to *WINTER* mode (all installed circuits are active)
- to *SUMMER* mode (circuits used for heating are put into standby mode)
- to *AUTOMATIC** mode (automatic switching from *SUMMER* to *WINTER* mode or vice versa depending on the outdoor temperature).

- Press  to access the setting:
- Turn the dial to access the setting:

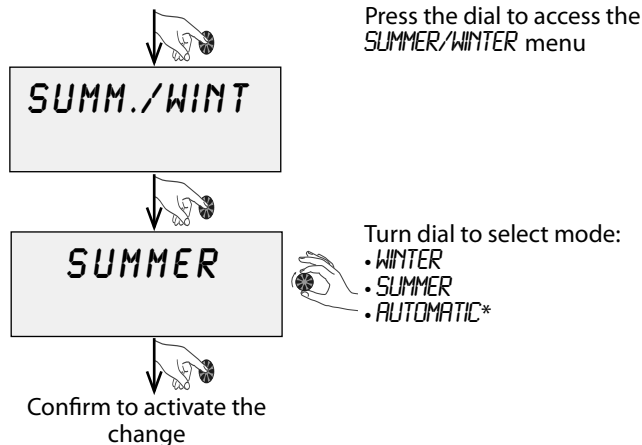

- Press  to return to main screen.

* Only with outdoor sensor, not possible with activation of the function «deduction of external temperature».

5.3.6 - Setting the language

- Press  to access the setting:
- Turn the dial to access the setting:

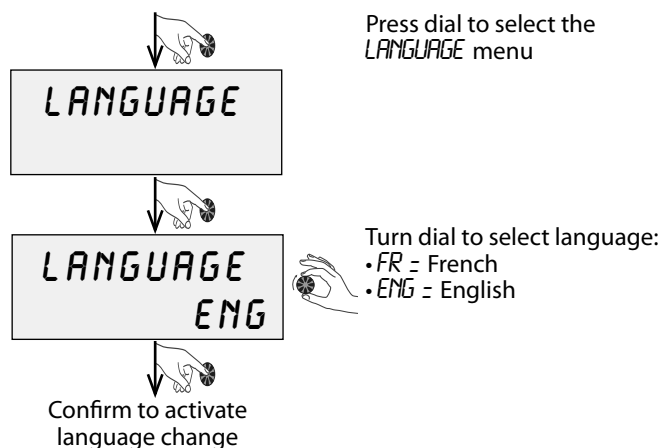

5.3.7 - Accessing measurements (temperatures, contact) and operating information (circulator pump and 3-way valve)

- Press and hold down dial for 3 seconds to access the "DISPLAY" menu.
- Turn the dial to scroll through the screens (see § "Maintenance and repairs")

6 - MAINTENANCE AND REPAIRS

LOCKING THE KEYBOARD

6.1 - Maintenance aids in the installer menu



6.1.1 - Accessing measurements (temperatures, contact) and operating information (circulator pump and 3-way valve)



N.B:

This sub-menu can be directly accessed from the main screen by pressing and holding down the dial for 3 seconds

Accessing the Installer Menu:

- Press  to access the setting:
- Turn dial until screen displays: "INST. MENU"
- Press "Clock settings"  and "Menu" at the same time
- **Hold both keys down** for 3 seconds to access the Installer Menu

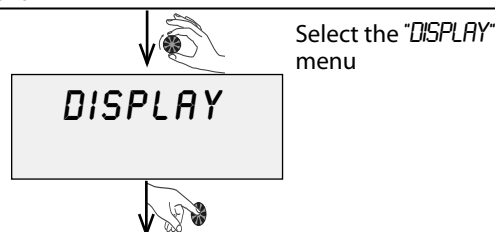



Display	Display example	Description	Point of reference on electronic board
AMBIENCE 1	20°C	Ambient temperature in heating zone n°1	Amb1
AMBIENCE 2	20.5°C	Ambient temperature in heating zone n°2	Amb2
OUTSIDE	-5°C	Outside temperature	Ext
BOILER	70°C	Temperature of heating water supplied by boiler	Tchaud
FLOOR HEA.	30°C	Leaving water temperature from 3-way valve of circuit 2 (mixed)	Tv3v
RETURN	55°C	Temperature of heating water returning to boiler	Tretour
CONTACT	0	External contact status (0=off; 1=on)	Contact externe
VALVE 2	190	Number of closing steps for 3-way valve (0=completely open; 190=completely closed)	Information on circulator pump and 3-way valves and target temperature for mixed circuit
PLUM 2	60%	Mixed circuit circulator pump speed	
Q2 (M3/H)	12 M3/H	Calculated flow-rate of mixed circuit circulator pump	
DP2 (MCE)	32 MCE	Calculated pressure drop of mixed circuit circulator pump	
PWM 2 INFO	60%	PWM signal feedback for mixed circuit circulator pump	
TARG. CIRC 2	35°C	Target leaving temperature from mixed circuit 3-way valve	



Turn the dial to scroll through the displays

6.1.2 - Viewing counters and meters

Accessing the Installer Menu:

- Press 
- Turn dial until screen displays: "INST. MENU"
- Press "Clock settings"  and "Menu" at the same time
- Hold both keys down for 3 seconds to access the Installer Menu



Select the "COUNTERS" menu

COUNTERS



Turn dial to scroll through different displays

The operating counters are numbered:

Upper display	Lower display	Description	Unit
99999 H	N°1	Direct circuit request time	hours
99999 H	N°2	Mixed circuit request time	hours
99999 H	N°3	Direct circuit operating time	hours
99999 H	N°4	Mixed circuit operating time	hours
99999	N°5	Bus defect (Counter will not delete)	number
99999	N°6	Overheating defect (counter will not delete)	number



N.B:

To reset the deleteable counters N°1, N°2 and N°3 press the dial and hold down for 3 seconds.



Press  at any time to return to previous screen without saving any changes.

6.2 - Locking the keyboard

When the keyboard is locked, the  symbol appears on the top right-hand side of the screen.

There are 3 locking levels:

Accessing the Installer Menu:

- Press 
- Turn dial until screen displays: "INST. MENU"
- Press «Clock settings»  and «Menu» at the same time
- Hold both keys down for 3 seconds to access the Installer Menu



Select the "LOCK" menu

LOCK



LOCK
NO

OR

LOCK
AUTO

LOCK
PRO

6.2.1 - Lock = NO

If "LOCK NO" is set:

From the main screen, press the  key for 3 seconds to access one of the following screens, signalling that the keyboard has just been locked or unlocked

LOCK

OR

UNLOCK

When the keyboard is locked, the  symbol appears at the top right hand side of the screen.



6.2.2 - Lock = AUTO

If "LOCK AUTO" is set:

- The keyboard will lock automatically after 30 seconds.
- To unlock the keyboard for 30 seconds press the  key and reply "yes" to the unlock question.

6.2.3 - Lock = PRO

If "LOCK PRO" is set:

- The keyboard locks automatically after 300 seconds.
- To unlock the keyboard for 300 seconds:
 - press  and hold down for 3 seconds
 - reply YES to the "unlock" question by pressing the  and  keys and holding down for 3 seconds

6.3 - Error messages

Errors are signalled by the backlighting of the screen flashing.

If it is an **automatic reset error**:

- resolving the issue that has generated the message will make it disappear automatically.

If it is a **manual reset error**:

- resolve the issue,
- press the dial to make the error message disappear.

Manual reset errors are signalled with this symbol: 

Ordre of priority	Display	Name	Source of defect	Consequences	Repairs Removing the error message
1	<i>BUS ERR</i>	BUS connection	Bus wire or board defect	Appliance non-functional	Change connecting wire or change boards if fault persists
2	<i>MEMORY ERR</i>	Electronics board memory defect	Electronics board defect	Appliance non-functional	Change electronics board
3	<i>AMBIENCE 1 ERR</i>	Zone 1 ambience sensor	Sensor defect or connection error	Circuit 1 non-functional	Change sensor, connection wire or configuration
4	<i>AMBIENCE 2 ERR</i>	Zone 2 ambience sensor	Sensor defect or connection error	Circuit 2 non-functional	Change sensor, connection wire or configuration
5	<i>T BOILER ERR</i>	Sensor for water leaving from boiler	Sensor defect or connection error	Circuit 1 non-functional	Change sensor or connection
6	<i>T RETURN ERR</i>	Sensor for water returning to the boiler	Sensor defect or connection error	None	Change sensor or connection
7	<i>T 3WV VALVE ERR</i>	Sensor for water leaving from the 3-way valve	Sensor defect or connection error	3-way valve closed (circuit 2 non-functional)	Change sensor or connection
8	<i>T OUTSIDE ERR</i>	Outside sensor defect	Sensor defect or connection error	Operation with manual temperature setting (= (MiOT+MOT)/2)	Change sensor, connection wire or configuration
9	<i>CLOCK ERR</i>	Electronic board clock defect	•1-Date and time not set •2-Electronics board defect	Appliance non-functional	•1-Press «clock settings» and set date and time •2-If the error message still does not disappear, replace the electronics board
10	<i>PRES. LOSS ERR</i>	Excessive pressure drop (>P263) despite running at maximum speed	Blockage or insufficient section on circuit	Circulator pump non-functional 4 attempts, then zone in question brought to a total stop	Press on dial to reset
11	<i>OVERHEAT FLOOR</i>	For underfloor heating: temperature of water leaving from 3-way valve on Circuit 2 (mixed) $\geq 60^{\circ}\text{C}$	Mixed circuit 3-way valve defect	Circulator pump non-functional + mixed circuit 3-way valve closed	Press on dial to reset (allowed if TWV $\leq 50^{\circ}\text{C}$)
12	<i>PWM2 IN BO</i>	Loss of PWM2 signal feedback	Circulator pump defect or PWM cable unplugged	Circulator pump runs to maximum speed (100%)	Change circulator pump or connection

6.4 - Sensor data curve charts

6.4.1 - Boiler, outgoing, incoming 3WV and DHW sensors

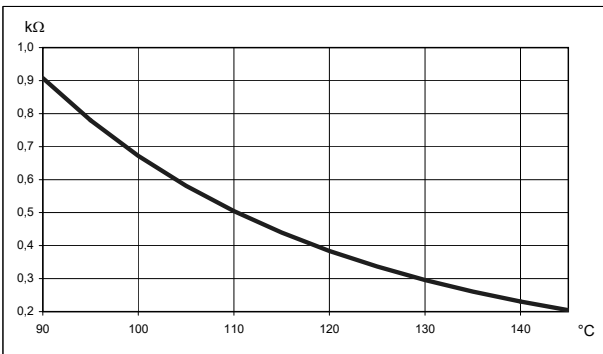
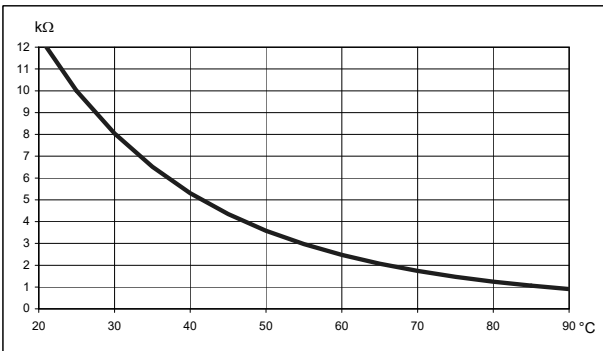
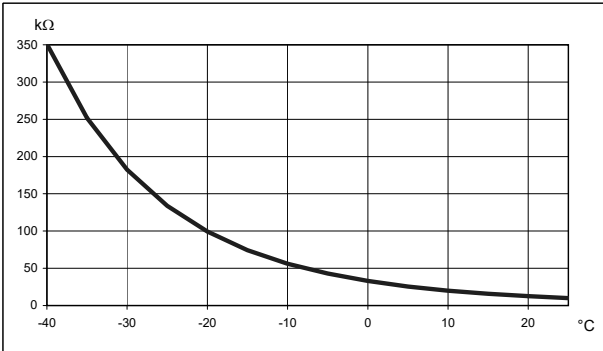

Temperature in °C	Sensor value in kOhms		
-40	351.078	55	2.968
-35	251.577	60	2.472
-30	182.451	65	2.068
-25	133.827	70	1.739
-20	99.221	75	1.469
-15	74.316	80	1.246
-10	56.202	85	1.061
-5	42.894	90	0.908
0	33.024	95	0.779
5	25.607	100	0.672
10	20.017	105	0.581
15	15.768	110	0.504
20	12.513	115	0.439
25	10.000	120	0.384
30	8.045	125	0.336
35	6.514	130	0.296
40	5.306	135	0.261
45	4.348	140	0.231
50	3.583	145	0.204

6.4.2 - Outdoor sensor

Temp. °C	Resistance Ω	Temp. °C	R Ohms Ω
-30	171 800	8	24 947
-29	161 817	9	23 853
-28	152 994	10	22 800
-27	144 697	11	21 819
-26	136 894	12	20 879
-25	129 800	13	19 986
-24	122 646	14	19 137
-23	116 145	15	18 300
-22	110 025	16	17 565
-21	104 261	17	16 839
-20	98 930	18	16 151
-19	93 713	19	15 500
-18	88 888	20	14 770
-17	84 339	21	14 168
-16	80 047	22	13 590
-15	76 020	23	13 039
-14	72 174	24	12 514
-13	68 564	25	12 000
-12	65 153	26	11 535
-11	61 930	27	11 079
-10	58 880	28	10 645
-9	56 004	29	10 231
-8	53 280	30	9 804
-7	50 702	31	9 460
-6	48 263	32	9 101
-5	45 950	33	8 759
-4	43 769	34	8 434
-3	41 699	35	8 054
-2	39 739	36	7 749
-1	37 881	37	7 456
0	36 130	38	7 176
1	34 453	39	6 909
2	32 871	40	6 652
3	31 371	41	6 408
4	29 948	42	6 173
5	28 600	43	5 947
6	27 317	44	5 731
7	26 101	45	5 522

6.5 - Maintenance

We would advise you to ask a qualified professional to carry out annual tests and maintenance in order to maximise the performance and life-span of the appliance.



• Any work on the Thorix EVOLUTION must be carried out by a qualified professional

- Please respect all safety instructions and advice.
- Make sure the Thorix EVOLUTION is switched off before opening it.
- Do not put water on any of the electrical components.



N.B:

In cases where maintenance is carried out or the Thorix EVOLUTION is taken out of service, please respect environmental protection rules regarding recovery, recycling and disposal of consumables and components.

6.5.1 - Water circuit

The only checks to be made on the water circuit are on the filters and to see if there are any leaks. Clean or replace dirty or clogged filters.

6.5.2 - Troubleshooting

If your **Thorix EVOLUTION** is not working,

check that:

- There is a heating request from the thermostat or sensors
- The appliance is connected to the power supply properly.
- The green light is on
- The appliance is not in holiday mode (suitcase symbol on)
- A programmed time period is not stopping the appliance from running ("Eco" symbol on)
- There is an error displayed on the screen (see §"Error messages").

7 - PARTS

Repère	Référence	Désignation
1	B1243534	Temperature sensor Tboiler + Treturn + T3WV
2	B4591973	Check valve
3	B1244204	Hydraubloc (circulateur + vanne motorisée)
		Circulator pump motor
4	B1244203	Power supply electronics board
5	B4992185	Display screen electronics board
6	B1239045	Underfloor heating temperature- limiting safety thermostat (65°C) (Black point)
	B1244401	Outdoor sensor
7	B1239213	2-way valve
8	B1244442	2-way valve motor

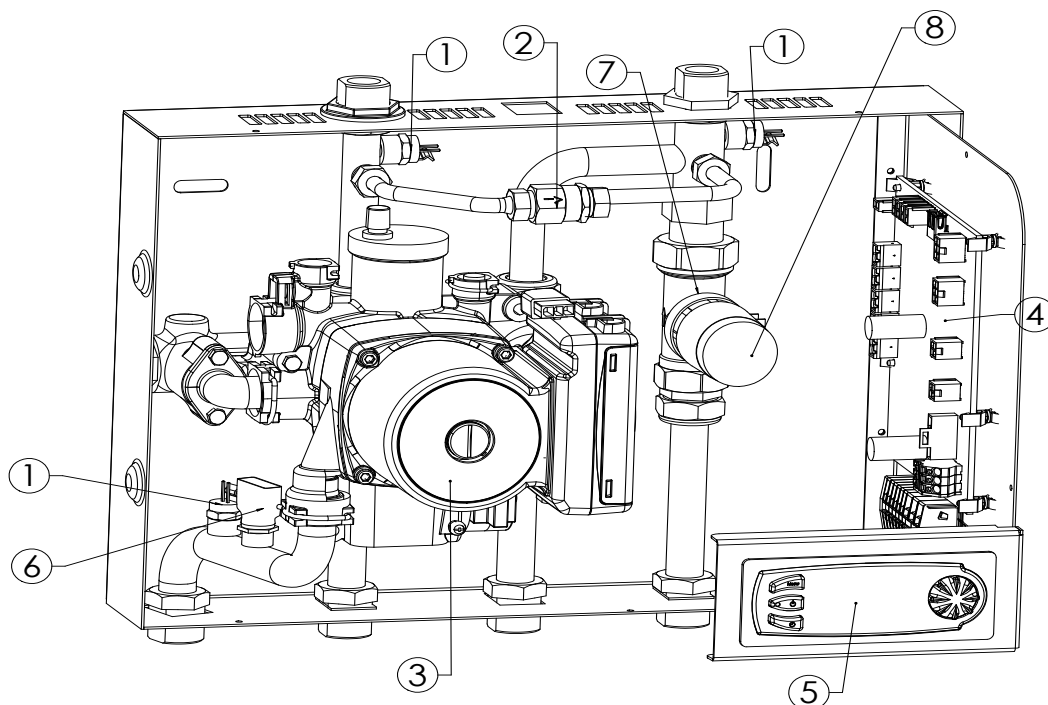

8 - WARRANTY

The warranty covers the **Thorix EVOLUTION** for a period of two (2) years, starting from the date the appliance was activated, if the warranty voucher was sent back to the manufacturer. In the absence of this document, the date of manufacture will be used to determine the start date.

The equipment is guaranteed against all manufacturing defects, on the express condition that it was installed by a qualified professional using our instruction manuals, the C15-100 standard for electrical connections and all current safety rules and regulations in effect in the country of installation.

A defective part does not warrant the whole appliance being replaced.

The warranty only extends to parts which we identify as having been defective at manufacture. If necessary, the part or product should be returned to the manufacturer but only with prior agreement from our technical department. Labour, transport and packaging costs are the responsibility of the user. Repairs on a device will not result in compensation.

The parts warranty ends at the same time as the appliance warranty. The warranty only applies to the appliance and its components and excludes any part or installation - electrical or hydraulic - external to the appliance.

Regular annual maintenance of the appliance and your installation is essential for ensuring sustained use and durability. This maintenance must be carried out either by your installer or a company where employees are **intuis** trained and approved.

In the absence of regular maintenance, the warranty will be void.

If an appliance is presumed to have been the cause of any damage, the appliance and the damage must be left as they are and not tampered with before an expert assessment has taken place.

8.1 - Warranty limits

8.1.1 - General information

The warranty does not apply to defects or damage caused by situations or events such as:

- Misuse, abuse, negligence, improper transport or handling.
- Incorrect installation, or installation which has been carried out without following the instructions in the manual and user guide.
- Insufficient maintenance.
- Modifications or changes carried out on the appliance.
- Impacts from foreign objects, fire, earthquakes, floods, lightning, ice, hailstones, hurricanes or any other natural catastrophe
- Movement, imbalance, collapse or settling of the ground or the structure where the appliance is installed.
- Any other damage which is not due to defects in the product.

We do not guarantee against discolouration or damage caused by air pollution, exposure to chemical elements or changes brought about by bad weather conditions.

The products are not guaranteed against dirt, rust, grease or stains which occur on the surface of the appliance. We are not responsible for variations in colour.

8.1.2 - Cases (unlimited) for exclusion from warranty

8.1.2.1 - Heating circuit water

Cases (non-limited) where warranty is void:

- The heating circuit not having been rinsed
- Use of rainwater or water from a well
- Filling water for the circuit not having been treated in accordance with the instructions given in this manual.

8.1.2.2 - Handling

Cases (unlimited) where warranty is void:

- Any damage sustained by impacts or falls during handling after delivery from the factory.
- Deterioration in the condition of the appliance after handling where the instructions in the manual have not been followed.

8.1.2.3 - Installation site

Cases (unlimited) where the warranty is void:

- Placing the **Thorix EVOLUTION** where it can be subject to ice or other bad weather conditions.
- No frost protection in place for the appliance and its equipment
- Installing the **Thorix EVOLUTION** on a wall which is not adapted to its weight.
- Positioning the appliance in a way which does not comply with the instructions given in this manual.

Costs incurred by access difficulties are not the manufacturer's responsibility.

8.1.2.4 - Electrical connections

Cases (unlimited) where the warranty is void:

- Faulty electrical connection which does not comply with the current national installation standards.
- Not following the connection diagrams in the instruction manual.
- Power supply being significantly under or over the required voltage.
- Failure to comply with supply cable sections.
- Absence of, or insufficient, electrical protection throughout the appliance (fuse / circuit-breaker, grounding etc).

8.1.2.5 - Hydraulic connections

Cases (unlimited) where warranty is void:

- Inverting the hot / cold water connections.
- Water pressure being higher than 2.5 bars.
- External corrosion caused by the piping not being correctly sealed.
- The installation not complying with the instructions given in this manual.

8.1.2.6 - Accessories

The warranty does not cover defects resulting from:

- fitting accessories which do not comply with our recommendations,
- using accessories which were not provided by us.

8.1.2.7 - Maintenance

Cases (non-limited) where the warranty is void:

- Not respecting the maintenance instructions which are given in this manual
- Not using parts that come from the manufacturer
- Bodywork and outer casing subjected to external factors
- Abnormal sludge levels

9 - GLOSSARY

Alarme	Voltage-free alarm signal
Alim	Power supply
Amb 1	Room temperature sensor 1
Amb 2	Room temperature sensor 2
Circ	Circulator pump
Contact.....	Dry contact
CT	Room thermostat with clock/timer
DHW	Domestic hot water
Ext	Outdoor temperature sensor
F	Fuse
G	Ground
GMiOT.....	Generator minimum outdoor temperature
GMiTT	Generator minimum target temperature
GMOT	Generator maximum outdoor temperature
GMTT.....	Generator maximum target temperature
MaTT2.....	Maximum target temperature for water outgoing from 3-way valve (circuit 2)
MaWT.....	Maximum water temperature
MiOT	Minimum outdoor temperature
MiTT2.....	Minimum target temperature for water outgoing from 3-way valve (circuit2)
MiWT.....	Minimum water temperature
MOT	Maximum outdoor temperature
N	Neutral
OS.....	Outdoor temperature sensor
Ph	Phase
RT.....	Room thermostat
RTS	Room temperature sensor
T	Temperature
Tchaud.....	Boiler outgoing water temperature sensor
Tecs	Domestic hot water temperature sensor
Tretour.....	Boiler incoming water temperature sensor
TT.....	Target temperature
TV3V	3-way valve temperature sensor
UTL.....	Underfloor temperature limiter
2WV	2-way valve

NOTES:



Industrial and development site

Rue de la République
CS 40029
80210 Feuquières-en-Vimeu
France

Spare parts

Tel. : +33 3 22 61 21 21
Fax : +33 3 22 61 33 35
E-mail : pieces@intuis.fr

Technical department

E-mail : sav@intuis.fr